

SIRCOVER

MANUALLY OPERATED CHANGEOVER SWITCHES

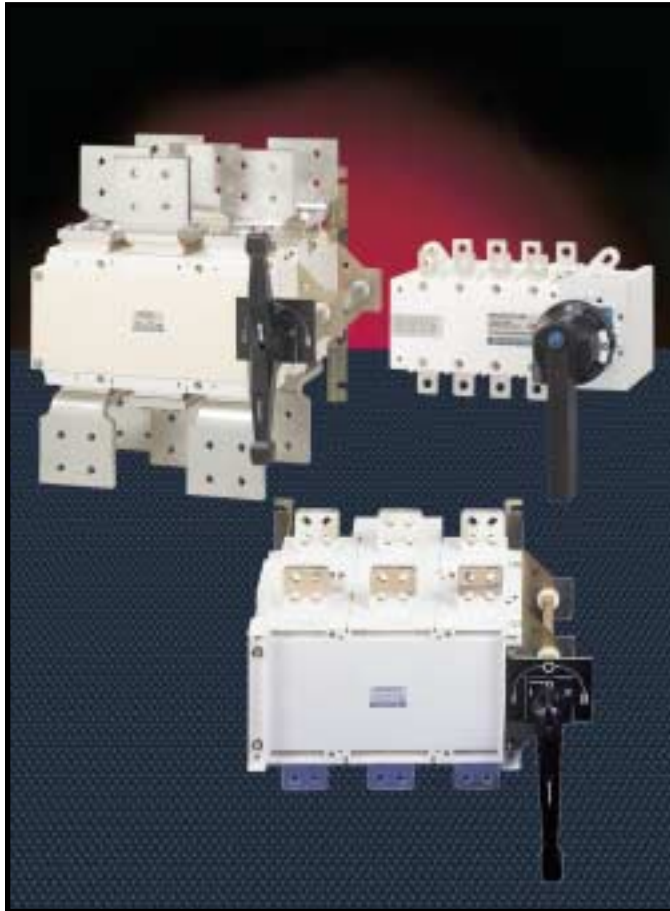

SIRCOVER are manually operated multipolar changeover switches.

They changeover between two low voltage power circuits under load and provide safety disconnection.

Application: NORMAL/EMERGENCY

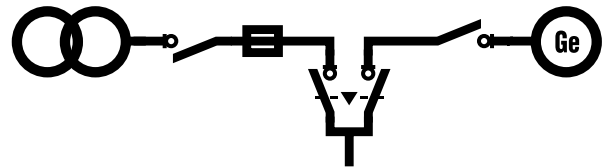

Application: EARTHING

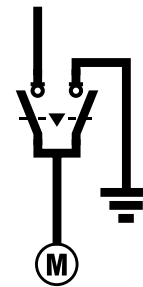

HIGHLIGHTS:

- Fully visualized breaking
- 3 stable positions (I-0-II or overlapping I-I+II-II)

APPLICATIONS:

- Manual changeover from main supply to back-up source
- Switching between loads (motor or back-up)
- Reversing motor via phase inversion
- Earthing switch

Ratings

- 125, 160, 200, 250, 400, 630, 800, 1250, 1600, 2000, 2500 and 3150 amperes

Approvals

- IEC 60947-3
- NF EN 60947-3
- VDE 0660 Teil 107 (1992)
- NBN EN 60947-3
- BS EN 60947-3

Note: Fully motorized versions available on request, please consult us.

SIRCOVER

MANUALLY OPERATED CHANGEOVER SWITCHES

SIRCOVER RANGE: Changeover Switches from 125 to 3150 Amperes



SELECT A SWITCH

AMPERE RATING

CD 125A	CD 160A	CD 200A
---------	---------	---------

SIRCOVER FOR I-0-II OPERATION

CATALOG NUMBER: 3 POLE

4100 3013	4100 3016	4100 3019
-----------	-----------	-----------

CATALOG NUMBER: 4 POLE

4100 4013	4100 4016	4100 4019
-----------	-----------	-----------

SIRCOVER FOR I-I+II-II OPERATION (OVERLAPPING)

CATALOG NUMBER: 3 POLE

4190 3013	4190 3016	4190 3019
-----------	-----------	-----------

CATALOG NUMBER: 4 POLE

4190 4013	4190 4016	4190 4019
-----------	-----------	-----------

EXTERNAL OPERATION



SELECT A HANDLE

TO SUIT SWITCH	PADLOCK POSITION	IP RATING	COLOR	CATALOG NUMBER		
I-0-II	0	IP54	Black	4199 5032	4199 5032	4199 5032
I-0-II	0	IP65	Black	4199 5036	4199 5036	4199 5036
I-0-II	I-0-II	IP54	Black	4199 5015	4199 5015	4199 5015
I-0-II	I-0-II	IP65	Black	4199 5016	4199 5016	4199 5016
I-I+II-II	I+II	IP54	Black	4199 5039	4199 5039	4199 5039
I-I+II-II	I-I+II-II	IP54	Black	4199 5019	4199 5019	4199 5019
I-I+II-II	I-I+II-II	IP65	Black	4199 7016	4199 7016	4199 7016



SELECT A SHAFT

SHAFT LENGTH (inches/mm)	CATALOG NUMBER		
7.9/200	3999 3004	3999 3004	3999 3004
12.6/320	3999 3013	3999 3013	3999 3013

DIRECT OPERATION

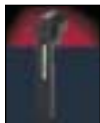

SELECT A HANDLE

TO SUIT SWITCH	PADLOCK POSITION	IP RATING	COLOR	CATALOG NUMBER		
I-0-II / I-I+II-II	I-0-II / I-I+II-II	—	Black	4199 5012	4199 5012	4199 5012

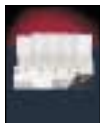

OPTIONS FOR I-0-II AND I-I+II-II CHANGEOVER SWITCHES	CATALOG NUMBER		
3-pole Terminal Shrouds Kit (IP20) ⁽¹⁾ Line + load shroud side / front terminals	4194 3013	4194 3013	4194 3013
Line + load shroud side / rear terminals	4195 3013	4195 3013	4195 3013
4-pole Terminal Shrouds Kit (IP20) ⁽¹⁾ Line + load shroud side / front terminals	4194 4013	4194 4013	4194 4013
Line + load shroud side / rear terminals	4195 4013	4195 4013	4195 4013
Bridging bars For 1 pole ⁽²⁾	4109 0019	4109 0019	4109 0019
Auxiliary contacts 1st NO.NC per position, 16A	4109 0021	4109 0021	4109 0021
2nd NO.NC ⁽³⁾ per position, 16A	4109 0021	4109 0021	4109 0021

Note: Door interlocking feature in ON position for external front operation

For any specific interlocking device (Ronis, Castell, Kirck), please consult us

(1) One shroud required for front and for back terminal, max two shrouds required

Cannot fit rear terminal shroud when bridging bars are fitted

(2) One bridging bar required per pole

(3) Mounted on the first aux. contact (part 4109 0021)

MANUALLY OPERATED CHANGEOVER SWITCHES



SELECT A SWITCH

AMPERE RATING

CD 250A	CD 400A	CD 630A
---------	---------	---------

SIRCOVER FOR I-0-II OPERATION

CATALOG NUMBER: 3 POLE

CATALOG NUMBER: 4 POLE

4100 3025	4100 3039	4100 3063
4100 4025	4100 4039	4100 4063

SIRCOVER FOR I-I+II-II OPERATION (OVERLAPPING)

CATALOG NUMBER: 3 POLE

CATALOG NUMBER: 4 POLE

4190 3025	4190 3039	4190 3063
4190 4025	4190 4039	4190 4063

EXTERNAL OPERATION



SELECT A HANDLE

TO SUIT SWITCH	PADLOCK POSITION	IP RATING	COLOR	CATALOG NUMBER		
I-0-II	0	IP54	Black	4199 5032	4199 5032	4199 5032
I-0-II	0	IP65	Black	4199 5036	4199 5036	4199 5036
I-0-II	I-0-II	IP54	Black	4199 5015	4199 5015	4199 5015
I-0-II	I-0-II	IP65	Black	4199 5016	4199 5016	4199 5016
I-I+II-II	I+II	IP54	Black	4199 5039	4199 5039	4199 5039
I-I+II-II	I-I+II-II	IP54	Black	4199 5019	4199 5019	4199 5019
I-I+II-II	I-I+II-II	IP65	Black	4199 7016	4199 7016	4199 7016



SELECT A SHAFT

SHAFT LENGTH (inches/mm)	CATALOG NUMBER		
7.9/200	3999 3004	3999 3004	3999 3004
12.6/320	3999 3013	3999 3013	3999 3013

DIRECT OPERATION

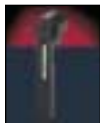

SELECT A HANDLE

TO SUIT SWITCH	PADLOCK POSITION	IP RATING	COLOR	CATALOG NUMBER		
I-0-II / I-I+II-II	I-0-II / I-I+II-II	—	Black	4199 5012	4199 5012	4199 5012

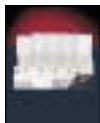

OPTIONS FOR I-0-II AND I-I+II-II CHANGEOVER SWITCHES	CATALOG NUMBER		
3-pole Terminal Shrouds Kit (IP20) ⁽¹⁾ Line + load shroud side / front terminals	4194 3025	4194 3025	4194 3050
Line + load shroud side / rear terminals	4195 3025	4195 3025	4195 3050
4-pole Terminal Shrouds Kit (IP20) ⁽¹⁾ Line + load shroud side / front terminals	4194 4025	4194 4025	4194 4050
Line + load shroud side / rear terminals	4195 4025	4195 4025	4195 4050
Bridging bars For 1 pole ⁽²⁾	4109 0025	4109 0039	4109 0063
Auxiliary contacts 1st NO.NC per position, 16A	4109 0021	4109 0021	4109 0021
2nd NO.NC ⁽³⁾ per position, 16A	4109 0021	4109 0021	4109 0021

Note: Door interlocking feature in ON position for external front operation

For any specific interlocking device (Ronis, Castell, Kirck), please consult us

(1) One shroud required for front and for back terminal, max two shrouds required

Cannot fit rear terminal shroud when bridging bars are fitted

(2) One bridging bar required per pole

(3) Mounted on the first aux. contact (part 4109 0021)

SIRCOVER

MANUALLY OPERATED CHANGEOVER SWITCHES



SELECT A SWITCH

AMPERE RATING	CD 800A	CD 1250A	1600A
---------------	---------	----------	-------

SIRCOVER FOR I-0-II OPERATION

CATALOG NUMBER: 3 POLE

CATALOG NUMBER: 4 POLE

4100 3080	4100 3120	4200 3160
4100 4080	4100 4120	4200 4160

SIRCOVER FOR I-I+II-II OPERATION (OVERLAPPING)

CATALOG NUMBER: 3 POLE

CATALOG NUMBER: 4 POLE

4190 3080	4190 3120	4290 3160
4190 4080	4190 4120	4290 4160

EXTERNAL OPERATION



SELECT A HANDLE

TO SUIT SWITCH	PADLOCK POSITION	IP RATING	COLOR	CATALOG NUMBER		
I-0-II	I-0-II	IP54	Black	4494 5125	4494 5125	4494 5125
I-0-II	I-0-II	IP65	Black	Consult us	Consult us	Consult us
I-I+II-II	I-I+II-II	IP54	Black	4494 5129	4494 5129	4494 5129



SELECT A SHAFT

SHAFT LENGTH (inches/mm)	CATALOG NUMBER		
7.9/200	2799 3015	2799 3015	2799 3015
17.7/450	2799 3019	2799 3019	2799 3019

DIRECT OPERATION



SELECT A HANDLE

TO SUIT SWITCH	PADLOCK POSITION	IP RATING	COLOR	CATALOG NUMBER		
I-0-II / I-I+II-II	I-0-II / I-I+II-II	—	Black	2799 7052	2799 7052	2799 7052



OPTIONS FOR I-0-II AND I-I+II-II CHANGEOVER SWITCHES				CATALOG NUMBER		
3-pole Terminal Screen	Line or load side / front terminals	2998 3080	2998 3080	2998 3120	2998 3120	2998 3120
4-pole Terminal Screen	Line or load side / front terminals	2998 4080	2998 4080	2998 4120	2998 4120	2998 4120
Bridging bars	For 1 pole ⁽¹⁾	4109 0080	4109 0120	4409 0160	4409 0160	4409 0160
Auxiliary contacts	1st NO.NC per position, 16A	4109 0021	4109 0021	4409 0021	4409 0021	4409 0021
	2nd NO.NC ⁽²⁾ per position, 16A	4109 0021	4109 0021	4409 0022	4409 0022	4409 0022

Note: Door interlocking feature in ON position for external front operation

For any specific interlocking device (Ronis, Castell, Kirck), please consult us

(1) One bridging bar required per pole

(2) Mounted on the first aux. contact (part 4109 0021 or 4409 0021)

SIRCOVER

MANUALLY OPERATED CHANGEOVER SWITCHES

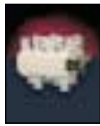

SELECT A SWITCH

AMPERE RATING	2000A	2500A	3150A
---------------	-------	-------	-------

SIRCOVER FOR I-0-II OPERATION

CATALOG NUMBER: 3 POLE

CATALOG NUMBER: 4 POLE

4200 3200	4200 3250	4200 3310
4200 4200	4200 4250	4200 4310

EXTERNAL OPERATION

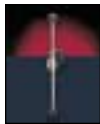

SELECT A HANDLE

TO SUIT SWITCH	PADLOCK POSITION	IP RATING	COLOR	CATALOG NUMBER		
I-0-II	I-0-II	IP65	Black	2799 7146	2799 7146	2799 7146

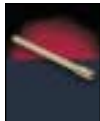

SELECT A SHAFT

SHAFT LENGTH (inches/mm)	CATALOG NUMBER		
12.6/320	2799 3018	2799 3018	2799 3018

DIRECT OPERATION

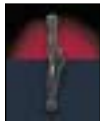

SELECT A HANDLE

TO SUIT SWITCH	PADLOCK POSITION	IP RATING	COLOR	CATALOG NUMBER		
I-0-II	I-0-II	—	Black	2799 7012	2799 7012	2799 7012



OPTIONS FOR I-0-II CHANGEOVER SWITCHES		CATALOG NUMBER		
3-pole Terminal Screen	Line + load side / front terminals	as standard	as standard	as standard
4-pole Terminal Screen	Line + load side / front terminals	as standard	as standard	as standard
Bridging bars	For 1 pole ⁽¹⁾ (factory fitted)	4409 0250	4409 0250	4409 0310
Auxiliary contacts	1st NO.NC per position, 16A	4409 0021	4409 0021	4409 0021
	2nd NO.NC ⁽²⁾ per position, 16A	4409 0022	4409 0022	4409 0022

Note: Door interlocking feature in ON position for external front operation
 For any specific interlocking device (Ronis, Castell, Kirck), please consult us
 (1) One bridging bar required per pole
 (2) Mounted on the first aux. contact (part 4409 0021)

SIRCOVER

MANUALLY OPERATED CHANGEOVER SWITCHES FROM 125 TO 3150 A

IEC 947-3 ELECTRICAL & MECHANICAL CHARACTERISTICS

Rating (Thermal current Ith at 40°C)	CD 125A	CD 160A	CD 200A	CD 250A	CD 400A	CD 630A
Rated insulation voltage Ui (V)	800	800	800	800	800	1000
Rated impulse withstand voltage Uimp (kV)	8	8	8	8	8	12
Dielectric strength (V) 50 Hz 1 min	5000	5000	5000	5000	5000	8000
Rated operational current Ie (A)⁽¹⁾	A/B	A/B	A/B	A/B	A/B	A/B
400 V AC AC 21A / AC 21B	125/125	160/160	200/200	250/250	400/400	630/630
AC 22A / AC 22B	125/125	160/160	200/200	250/250	400/400	630/630
AC 23A / AC 23B	125/125	160/160	160/160	250/250	250/250	500/500
690 V AC ⁽²⁾ AC 20A / AC 20B	125/125	160/160	200/200	250/250	400/400	630/630
AC 21A / AC 21B	125/125	160/160	160/160	200/250	200/250	500/500
AC 22A / AC 22B	125/125	125/125	125/125	125/160	125/160	315/315
AC 23A / AC 23B	63/80	63/80	63/80	100/125	100/125	160/200
220 V DC DC 20A / DC 20B	125/125	160/160	200/200	250/250	400/400	630/630
DC 21A / DC 21B	125/125	160/160	160/160	250/250	250/250	630/630
DC 22A / DC 22B	125/125	160/160	160/160	250/250	250/250	500/500
DC 23A / DC 23B	125/125	125/125	125/125	200/200	200/200	500/500
440 V DC DC 20A / DC 20B	125/125	160/160	200/200	250/250	400/400	630/630
DC 21A / DC 21B	125/125	125/125	125/125	200/200	200/200	500/500
DC 22A / DC 22B	125/125	125/125	125/125	200/200	200/200	500/500
DC 23A / DC 23B	125 ⁽³⁾ /80	125 ⁽³⁾ /125 ⁽³⁾	125 ⁽³⁾ /125 ⁽³⁾	200 ⁽³⁾ /200 ⁽³⁾	200 ⁽³⁾ /200 ⁽³⁾	500 ⁽³⁾ /500 ⁽³⁾
Motor Power (kW)⁽¹⁾	A/B	A/B	A/B	A/B	A/B	A/B
400 V AC without pre break auxiliary contact: AC 23	63/63	80/80	80/80	132/132	132/132	280/280
690 V AC without pre break auxiliary contact: AC 23	55/75	55/75	55/75	90/110	90/110	150/185
Overload capacity						
Fuse-protected short circuit withstand (kA rms prospective) with gG DIN fuse ⁽⁴⁾	100	100	50	50	18	70
Rating of DIN gG fuse (A)	125	160	200	250	400	630
Cut-off current (kA peak)	18	18	18	23	23	45
Rated short-time withstand current Icw (kA rms 1s)	7	7	7	9	9	13
Making & Breaking capacity characteristics (A rms)						
Breaking capacity: 400V AC 23A	1000	1280	1280	2000	2000	4000
Making capacity: 400V AC 23A	1250	1600	1600	2500	2500	5000
Rated short-circuit making capacity Icm (kA peak prospective)	11.9	11.9	11.9	15.3	15.3	26
Mechanical durability (number of operations)	10 000	10 000	10 000	10 000	10 000	5 000
Operating torque (Nm)	6.5	6.5	7	10	10	14.5
Connection (copper)						
Minimum section at Ith (mm ²) (Cu cables)	35	50	50	95	185	2 x 150
Maximum section (mm ²) (cables)	50	95	95	150	240	2 x 300
Minimum section at Ith (mm ²) (Cu busbar)						2 x 30 x 5
Maximum width (mm) (busbar)	25	25	25	32	32	50
Minimum tightening torque (Nm)	9	9	9	20	20	20
Weight (kg)						
3-pole switch	1.5	1.6	1.8	2.0	3.0	3.5
4-pole switch	1.6	1.7	1.9	2.1	3.5	4.0

(1) "A" indication=frequent operations

"B" indication=infrequent operations

(2) With terminal shrouds or separation shield between terminals

(3) 4 pole changeover switch with 2 poles in series per polarity

(4) For a rated operating voltage Ue=400 V AC

SIRCOVER

MANUALLY OPERATED CHANGEOVER SWITCHES FROM 125 TO 3150 A

IEC 947-3 ELECTRICAL & MECHANICAL CHARACTERISTICS

Rating (Thermal current Ith at 40°C)	CD 800A	CD 1250A	1600A	2000A	2500A	3150A
Rated insulation voltage Ui (V)	1000	1000	1000	1000	1000	1000
Rated impulse withstand voltage Uimp (kV)	12	12	12	12	12	12
Dielectric strength (V) 50 Hz 1 min	—	—	10000	10000	10000	10000
Rated operational current Ie (A)⁽¹⁾	A/B	A/B	A/B	A/B	A/B	A/B
400 V AC AC 21A / AC 21B	800/800	1250/1250	1600/1600	2000/2000	2500/2500	3150/3150
AC 22A / AC 22B	800/800	1250/1250	1250/1250	2000/2000	2000/2500	2500/2500
AC 23A / AC 23B	800/800	1250/1250	1000/1000	1250/1250	1250/1250	1250/1250
690 V AC ⁽²⁾ AC 20A / AC 20B	800/800	1250/1250	1600/1600	2000/2000	2500/2500	3150/3150
AC 21A / AC 21B	800/800	—	1600/1600	2000/2000	2000/2500	2000/2500
AC 22A / AC 22B	800/800	—	800/800	1000/1000	1000/1000	1000/1000
AC 23A / AC 23B	—	—	500/500	800/800	800/800	800/800
220 V DC DC 20A / DC 20B	800/800	1250/1250	1600/1600	2000/2000	2500/2500	3150/3150
DC 21A / DC 21B	800/800	1250/1250	1600/1600	2000/2000	2000/2500	2000/2500
DC 22A / DC 22B	800/800	1250/1250	1250/1250	1250/1600	1250/1600	1250/1600
DC 23A / DC 23B	800/800	1250/1250	1250 ⁽³⁾ /1250 ⁽³⁾	1250 ⁽³⁾ /1250 ⁽³⁾	1250 ⁽³⁾ /1250 ⁽³⁾	1250 ⁽³⁾ /1250 ⁽³⁾
440 V DC DC 20A / DC 20B	800/800	1250/1250	1600/1600	2000/2000	2500/2500	3150/3150
DC 21A / DC 21B	800 ⁽³⁾ /800 ⁽³⁾	1250 ⁽³⁾ /1250 ⁽³⁾	1250/1250	1250/1250	1250/1250	1250/1250
DC 22A / DC 22B	800 ⁽³⁾ /800 ⁽³⁾	1250 ⁽³⁾ /1250 ⁽³⁾	1250 ⁽³⁾ /1250 ⁽³⁾	1250 ⁽³⁾ /1250 ⁽³⁾	1250 ⁽³⁾ /1250 ⁽³⁾	1250 ⁽³⁾ /1250 ⁽³⁾
DC 23A / DC 23B	800 ⁽³⁾ /800 ⁽³⁾	1250 ⁽³⁾ /1250 ⁽³⁾	1000 ⁽³⁾ /1000 ⁽³⁾	1000 ⁽³⁾ /1000 ⁽³⁾	1000 ⁽³⁾ /1000 ⁽³⁾	1000 ⁽³⁾ /1000 ⁽³⁾
Motor Power (kW)⁽¹⁾	A/B	A/B	A/B	A/B	A/B	A/B
400 V AC without pre break auxiliary contact: AC 23	—	560/560	560/560	710/710	710/710	710/710
690 V AC without pre break auxiliary contact: AC 23	—	400/475	475/475	750/750	750/750	750/750
Overload capacity						
Fuse-protected short circuit withstand (kA rms prospective) with gG DIN fuse ⁽⁴⁾	50	100	100	100	100	100
Rating of DIN gG fuse (A)	800	1250	2 x 800	2 x 1000	2 x 1250	—
Cut-off current (kA peak)	—	—	86	120	120	120
Rated short-time withstand current Icw (kA rms 1s)	—	—	50	50	50	55
Making & Breaking capacity characteristics (A rms)						
Breaking capacity: 400V AC 23A	—	—	8000	10000	10000	10000
Making capacity: 400V AC 23A	—	—	10000	12500	12500	12500
Rated short-circuit making capacity Icm (kA peak prospective)	—	—	66	80	80	80
Mechanical durability (number of operations)	3000	3000	3000	3000	2500	2500
Operating torque (Nm)	—	—	37	60	60	60
Connection (copper)						
Minimum section at Ith (mm ²) (Cu cables)	2 x 185	—	—	—	—	—
Maximum section (mm ²) (cables)	2 x 300	4 x 185	6 x 240	—	—	—
Minimum section at Ith (mm ²) (Cu busbar)	2 x 40 x 5	2 x 60 x 5	2 x 80 x 5	3 x 100 x 5	4 x 100 x 5	4 x 100 x 5
Maximum width (mm) (busbar)	63	100	100	125	125	125
Minimum tightening torque (Nm)	—	20	40	40	40	40
Weight (kg)						
3-pole switch	—	22.5	34	70	72	98
4-pole switch	—	27.5	42	85	88	110

(1) "A" indication=frequent operations

"B" indication=infrequent operations

(2) With terminal shrouds or separation shield between terminals

(3) 4 pole changeover switch with 2 poles in series per polarity

(4) For a rated operating voltage Ue=400 V AC

SIRCOVER

MANUALLY OPERATED CHANGEOVER SWITCHES

DIMENSIONS (DUAL DIMENSIONS: IN/MM)

SIRCOVER CD 125-1250 A

Direct front operation

External front operation

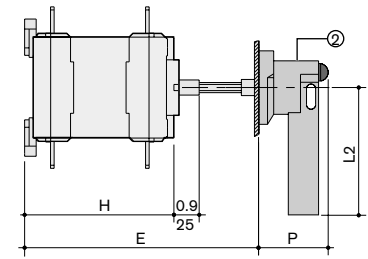
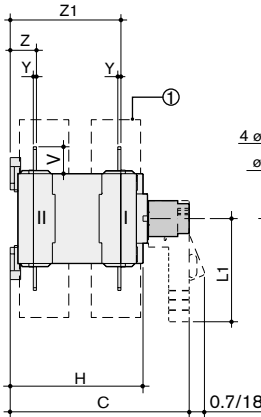
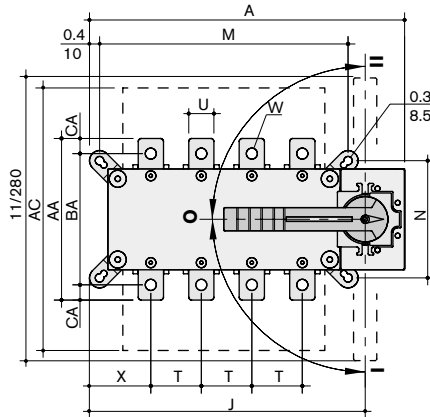

1. Terminal shrouds

2. Handle:

125 to 630 A: P=2.75/70, L1=5.51/140, L2=4.98/126.5
800 to 1250 A: P=4.17/106, L1=8.27/210, L2=8.27/210

RATING (A)	OVERALL DIMENSIONS (in)						SWITCH MOUNTING (in)					CONNECTION TERMINALS (in)											
	A 3p	A 4p	C	E	AC	H	J 3p	J 4p	M 3p	M 4p	N	T	U	V	W	X 3p	X 4p	Y	Z	Z ₁	AA	BA	CA
125	8.7	9.9	8.6	8.2 to 17.2	9.3	5.8	7.2	8.3	6.1	7.3	4.0	1.4	0.8	1.0	0.3	2.2	2.0	0.1	1.1	4.9	5.3	4.5	0.4
160	8.7	9.9	8.6	8.2 to 17.2	9.3	5.8	7.2	8.3	6.1	7.3	4.0	1.4	0.8	1.0	0.3	2.2	2.0	0.1	1.1	4.9	5.3	4.5	0.4
200	8.7	9.9	8.6	8.2 to 17.2	9.3	5.8	7.2	8.3	6.1	7.3	4.0	1.4	0.8	1.0	0.3	2.2	2.0	0.1	1.1	4.9	5.3	4.5	0.4
250	10.3	12.3	8.6	8.2 to 17.2	11.0	5.8	8.8	10.7	7.7	9.7	4.6	2.0	1.0	1.2	0.4	2.4	2.4	0.1	1.2	4.9	6.3	5.1	0.4
400	10.3	12.3	8.6	8.2 to 17.2	11.0	5.8	8.8	10.7	7.7	9.7	4.6	2.0	1.4	1.4	0.4	2.4	2.4	0.1	1.2	4.9	6.7	5.5	0.6
630	12.6	14.9	11.6	11.2 to 20.2	15.7	8.9	10.7	13.1	9.7	12.0	6.9	2.6	1.8	2.0	0.5	2.8	2.6	0.2	1.7	7.1	10.2	8.7	0.8
800	15.2	18.3	14.7	15.0 to 17.0	—	11.5	12.1	15.2	13.2	13.2	9.8	3.1	2.0	2.4	0.6	1.9	1.9	0.3	2.6	10.0	12.6	—	1.0
1250	15.2	18.3	14.7	15.0 to 17.0	—	11.5	12.1	15.2	13.2	13.2	9.8	3.1	2.4	2.6	0.6/0.4	1.9	1.9	0.3	2.6	10.0	13.0	—	1.2

RATING (A)	OVERALL DIMENSIONS (mm)						SWITCH MOUNTING (mm)					CONNECTION TERMINALS (mm)											
	A 3p	A 4p	C	E	AC	H	J 3p	J 4p	M 3p	M 4p	N	T	U	V	W	X 3p	X 4p	Y	Z	Z ₁	AA	BA	CA
125	221	251	218	208 to 436	235	148	182	212	156	186	101	36	20	25	8.5	56	50	3.5	28	124	135	115	10
160	221	251	218	208 to 436	235	148	182	212	156	186	101	36	20	25	8.5	56	50	3.5	28	124	135	115	10
200	221	251	218	208 to 436	235	148	182	212	156	186	101	36	20	25	8.5	56	50	3.5	28	124	135	115	10
250	262	312	218	208 to 436	280	148	223	273	196	246	116	50	25	30	11	61	61	3.5	30	124	160	130	10
400	262	312	218	208 to 436	280	148	223	273	196	246	116	50	35	35	11	61	61	3.5	30	124	170	140	15
630	319	379	295	285 to 513	400	225	272	332	246	306	176	65	45	50	13	70.5	65.5	5	43	180	260	220	20
800	386	466	374	382 to 432	—	293	306.5	386.5	336	336	250	80	50	60.5	15	48	48	7	66.5	253.5	321	—	26.5
1250	386	466	374	382 to 432	—	293	306.5	386.5	336	336	250	80	60	65	16x11	48	48	7	66.5	253.5	330	—	29.5

SIRCOVER

MANUALLY OPERATED CHANGEOVER SWITCHES

DIMENSIONS (DUAL DIMENSIONS: IN/MM)

SIRCOVER 1600 A

Direct front operation

External front operation

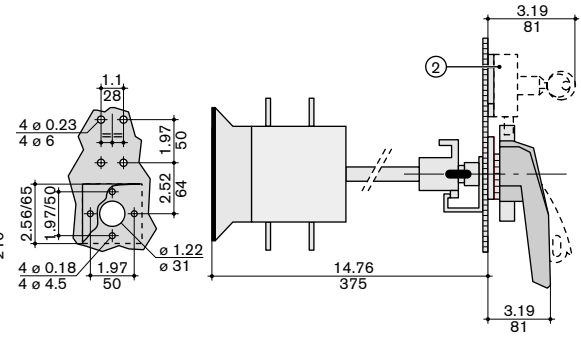
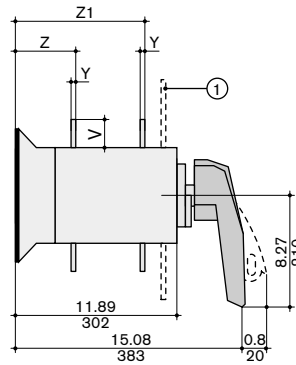
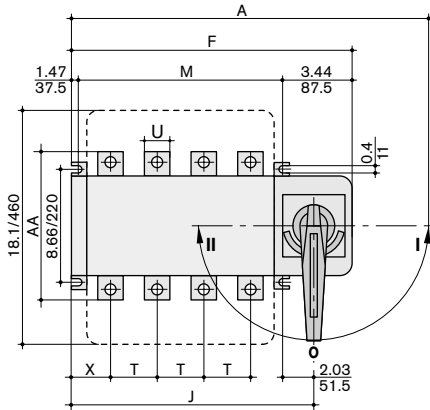

1. Terminal screen

2. RONIS EL 11 AP lock

RATING (A)	OVERALL DIMENSIONS (in)				SWITCH MOUNTING		CONNECTION TERMINALS (in)									
	A 3p	A 4p	F 3p	F 4p	J 3p	J 4p	M 3p	M 4p	T	U	V	X	Y	Z	Z ₁	AA
1600	24.4	29.2	18.6	23.3	17.2	21.9	13.7	18.4	4.7	3.1	3.1	2.4	0.6	4.4	10.0	14.2

RATING (A)	OVERALL DIMENSIONS (mm)				SWITCH MOUNTING		CONNECTION TERMINALS (mm)									
	A 3p	A 4p	F 3p	F 4p	J 3p	J 4p	M 3p	M 4p	T	U	V	X	Y	Z	Z ₁	AA
1600	621	741	472	592	436	556	347	467	120	80	80	60.5	15	111	253	360

Notes: Mounting orientation: rotation of some devices may be limited. Please consult us.

SIRCOVER

MANUALLY OPERATED CHANGEOVER SWITCHES

DIMENSIONS

SIRCOVER 2000-3150 A

Direct front operation

External front operation

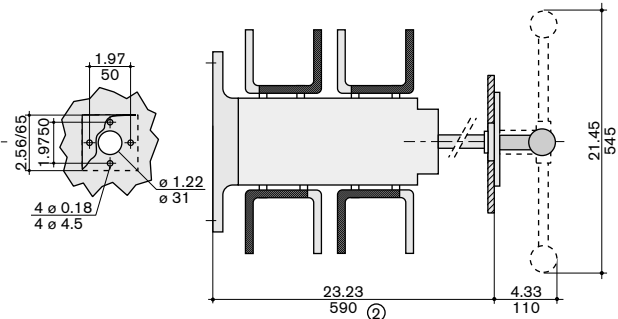
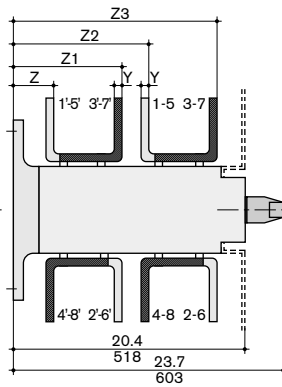
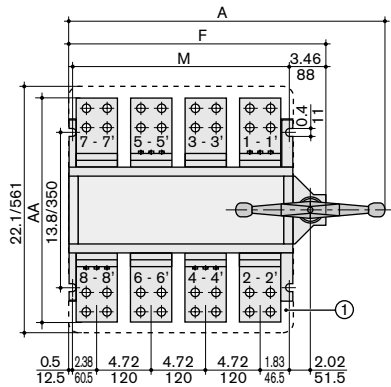

1. Terminal screen

2. Minimum dimension with shaft extension: 25/638

RATING (A)	OVERALL DIMENSIONS (in)				SWITCH MOUNTING (in)		CONNECTION TERMINALS (in)					
	A 3p	A 4p	F 3p	F 4p	M 3p	M 4p	Y	Z	Z ₁	Z ₂	Z ₃	AA
2000	22.7	27.4	17.6	22.3	13.7	18.4	0.4	3.1	8.9	12.2	18.0	17.9
2500	22.7	27.4	17.6	22.3	13.7	18.4	0.4	3.1	8.9	12.2	18.0	17.9
3150	22.7	27.4	17.6	22.3	13.7	18.4	0.6	3.1	9.1	12.2	18.2	19.9

RATING (A)	OVERALL DIMENSIONS (mm)				SWITCH MOUNTING (mm)		CONNECTION TERMINALS (mm)					
	A 3p	A 4p	F 3p	F 4p	M 3p	M 4p	Y	Z	Z ₁	Z ₂	Z ₃	AA
2000	576	696	447.5	567.5	347	467	10	78.5	225.5	309.5	456.5	455
2500	576	696	447.5	567.5	347	467	10	78.5	225.5	309.5	456.5	455
3150	576	696	447.5	567.5	347	467	15	78.5	230.5	309.5	461.5	505

Notes: Mounting orientation: rotation of some devices may be limited. Please consult us.

CONNECTION TERMINALS

SIRCOVER CD 800 A

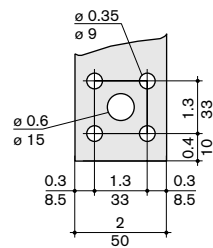

SIRCOVER CD 1250 A

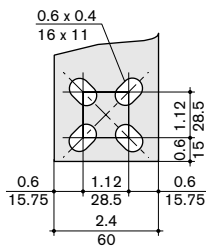

SIRCOVER 1600-2500 A

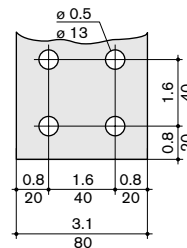

SIRCOVER 3150 A

