

PSC SQUARE BODY

690/700 Volt

SEMICONDUCTOR PROTECTION FUSES



Ferraz Shawmut 690/700V PSC fuse-links provide maximum flexibility in equipment design and ultimate protection for today's power conversion equipment. These square body fuse-links are available in four different body sizes, each size having seven worldwide acceptable mounting styles. The different mounting styles and body sizes along with a broad range of ampere ratings allow greatest flexibility in equipment design.

The Ferraz Shawmut PSC fuses have been engineered to provide state-of-the-art protection for SCR's, diodes, thyristors, GTO's and IGBT devices. They have pure silver, die-cut elements embedded in solidified sand, which helps control arcing characteristics for low I^2t and high interrupting rating. All contact surfaces are silver plated and all hardware is non-magnetic.

All fuse links are equipped with a low voltage trip-indicator. This trip-indicator can operate a field mountable microswitch which is easily mounted directly onto the fuse even while in service.

HIGHLIGHTS:

- Extremely Fast Acting
- Current Limiting
- Very Low I^2t
- Worldwide Acceptability
- Superior Cycling Ability

APPLICATIONS:

- Protection of rectifiers, inverters, DC drives, UPS Systems, reduced voltage motor starters, and other equipment in globally accepted applications

Features/Benefits

- **Choice of mounting styles** gives wide choice for equipment design
- **Broad range of ampere ratings** in a given body size for design flexibility
- **IEC 269-4 compliance** for worldwide semiconductor applications

Ratings

- **AC:** 40-2500A
500-700 VAC
200 kA IR
- **DC:** Consult Factory

Approvals

- UL Recognized Component
- Sizes 30,31,32,33 tested to IEC 269.4

* For Microswitch information see page J10



Part Number Designation:

6,9 URD: European/IEC
Mounting Style/Approval
Tested @ 1.1 V_N

A070 URD: North American
Mounting Style/Approval
Tested @ V_N

* V_N = rated voltage

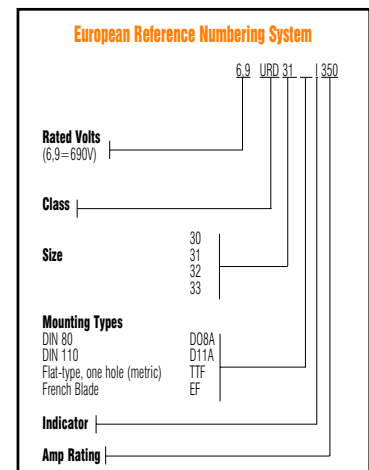
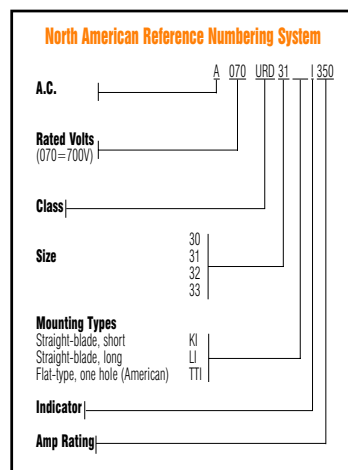

Outline Dimensions

Types D08A and D11A

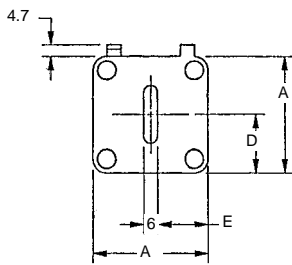
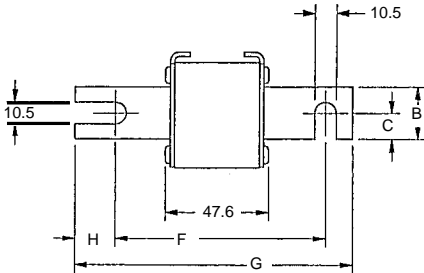

Dimensions

European Blade, Type D08A

CATALOG NO.	DIMENSIONS - mm						
	A	B	C	D	E	F	G
6,9 URD 30 D08A (50-550)	40	25	12.5	21	17	77	110
6,9 URD 31 D08A (40-1000)	51	25	12.5	25	22.5	77	110
6,9 URD 31 D08A (40-1000) 6 URD 32 D08A 1250	60	32	16	30	27	77	110
6,9 URD 33 D08A (500-1400) 6 URD 33 D08A (1600-1800)	74.5	40	20	37.2	34.25	77	110

European Blade, Type D11A

CATALOG NO.	DIMENSIONS - mm						
	A	B	C	D	E	F	G
6,9 URD 30 D11A (50-550)	40	25	12.5	21	17	101.6	134.6
6,9 URD 31 D11A (200-800)	51	25	12.5	25.5	22.5	101.6	134.6
6,9 URD 32 D11A (400-1000)	60	32	16	30	27	101.6	134.6
6,9 URD 33 D11A (500-1400) 6 URD 33 D11A (500-1400)	74.5	40	20	37.2	34.25	101.6	134.6



Dimensions

North American Straight Blade, Type KI

CATALOG NO.	DIMENSIONS - mm/(in)									
	A	B	C	D	E	F	G	H	J	
A070 URD 30 KI (63-550)	40 (1.57)	25 (.98)	12.5 (.49)	21 (.83)	18 (.71)	68 (2.68)	107 (4.21)	129 (5.08)	10.5 (.41)	
A070 URD 31 KI (200-800)	51 (2.01)	25 (.98)	12.5 (.49)	25.5 (1.0)	22.5 (.89)	67.6 (2.66)	107.1 (4.22)	128.8 (5.07)	14.3 (.56)	
A070 URD 32 KI (400-1000)	60 (2.36)	32 (1.26)	16 (.63)	30 (1.18)	27 (1.06)	74.2 (2.92)	109 (4.29)	134 (5.28)	14.6 (.57)	
A070 URD 33 KI (500-1400)	74.5 (2.93)	40 (1.57)	20 (.79)	37.2 (1.46)	34.2 (1.35)	75.4 (2.97)	107.6 (4.24)	134 (5.28)	15.9 (.63)	

Types KI and LI

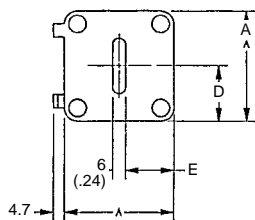
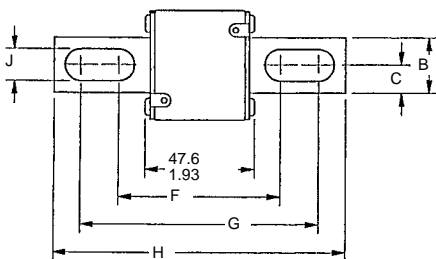

North American Straight Blade, Type LI

CATALOG NO.	DIMENSIONS - mm/(in)									
	A	B	C	D	E	F	G	H	J	
A070 URD 30 LI (63-550)	40 (1.57)	25 (.98)	12.5 (.49)	21 (.83)	18 (.71)	87.6 (3.45)	126.6 (4.98)	148.6 (5.85)	10.5 (.41)	
A070 URD 31 LI (200-800)	51 (2.01)	25 (.98)	12.5 (.49)	25.5 (1.0)	22.5 (.89)	91.6 (3.61)	122.4 (4.82)	148.6 (5.85)	14.6 (.57)	
A070 URD 32 LI (400-1000) A065 URD 32 LI 1250 A055 URD 32 LI (1400-1600) A050 URD 32 LI 1800	60 (2.36)	32 (1.26)	16 (.63)	30 (1.18)	27 (1.06)	94.2 (3.71)	129 (5.08)	153 (6.02)	14.6 (.57)	
A070 URD 33 LI (500-1400) A065 URD 33 LI (1600-1800) A060 URD 33 LI (2000) A055 URD 33 LI 2250 A050 URD 33 LI (2500)	74.5 (2.93)	40 (1.57)	20 (.79)	37.2 (1.46)	34.2 (1.35)	94.4 (3.72)	126.6 (4.98)	153 (6.02)	15.9 (.63)	

PSC SQUARE BODY 690/700 Volt

SEMICONDUCTOR PROTECTION FUSES

Outline Dimensions

Types TTI and TTF

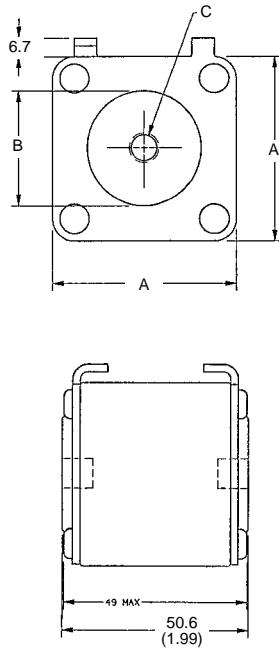

North American Flat Single Hole, Type TTI

CATALOG NO.	DIMENSIONS - In/(mm)		
	A	B	C
A070 URD 30 TTI (100-550)	1.57 (40)	1.00 (25)	5/16-18 x .35
A070 URD 31 TTI (200-800)	2.00 (50.8)	1.19 (30.2)	5/16-18 x .35
A070 URD 32 TTI (400-1000) A065 URD 32 TTI 1100 A060 URD 32 TTI 1250 A055 URD 32 TTI (1400-1600)	2.37 (60.3)	1.50 (38.1)	3/8-16 x .35
A060 URD 33 TTI 1800 A070 URD 33 TTI (500-1400) A065 URD 33 TTI 1600 A060 URD 33 TTI 2000 A055 URD 33 TTI 2250 A050 URD 33 TTI 2500	2.94 (74.6)	1.81 (46)	1/2-13 x .35

European Flat Single Hole, Type TTF

CATALOG NO.	DIMENSIONS - mm		
	A	B	C
6,9 URD 30 TTF (50-550)	40	26	M8 x 1.25 x 9 DP
6,9 URD 31 TTF (200-800)	51	30	M8 x 1.25 x 9 DP
6,9 URD 32 TTF (400-1000) 6 URD 32 TTF 1100	60	38	M10 x 1.50 x 9 DP
6,9 URD 33 TTF (500-1400) 6 URD 33 TTF (1500-1800) 5,5 URD 33 TTF 2000 5 URD 33 TTF 2250 4,5 URD 33 TTF 2500	74.5	46	M12 x 1.75 x 9 DP

Standard Threaded Studs

SIZE	REF. AND DIMENSION PER PAIR OF STUDS	WEIGHT (g)	MAX STUD MOUNTING TORQUE (Nm)	MAX NUT TIGHTENING TORQUE (Nm)		
				FIG1	FIG 2	FIG 3
30 & 31	S 98 801 (HC M8 X 30 & M 8 X 35)	23	10	13.5	13.5	13.5
32	T 98 802 (HC M 10 X 30 & M 10 X 50)	40	15	26	26	26
33	V 98 803 (HC M 12 X 35 & M 12 X 50)	60		46	46	46
2X32	W 98 804 (HC M 10 X 50)	50		26	26	26
2X33	X 98 805 (HC M 12 X 50)	70		46	46	46

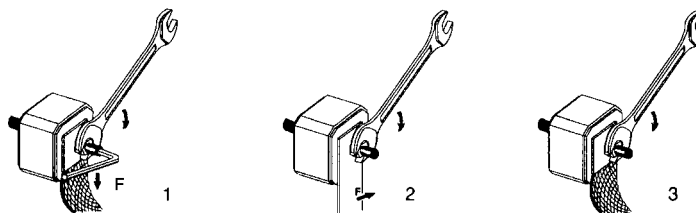

690/700 Volt

SEMICONDUCTOR PROTECTION FUSES

Outline Dimensions

Type EF

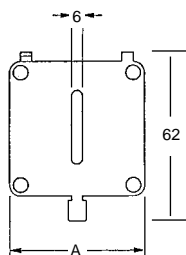
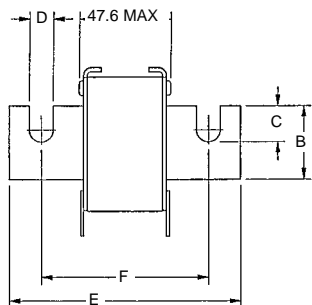

Dimensions

European French Blade, Type EF

CATALOG NO.	DIMENSIONS - mm					
	A	B	C	D	E	F
6,9 URD 30 EF (50-400)	40	18	11	9	100	76.6
6,9 URD 31 EF (200-700)	50	25	16	10.5	110	86.5
6,9 URD 32 EF (400-1000)	59	32	21.2	13	125.8	90.8
6,9 URD 33 EF (500-1400)	74.5	40	19.5	13	126	91



690/700 Volt

SEMICONDUCTOR PROTECTION FUSES

690 Volt European/IEC Style Ratings and Application Data

Body Size	Amp Rating	Rated Voltage	Melting I ² t (A ² s x 10 ³)	Total I ² t @ 660VAC (A ² s x 10 ³)	**Watts Loss @ Rated Current (W)	DIN 110 Catalog No. Type D11A	DIN 80 Catalog No. Type D08A	French Blade Catalog No. Type EF	Tapped Single Catalog No. Type TTF
30	50	690	0.116	0.68	9	6,9URD30D11A0050	6,9URD30D08A0050	6,9URD30EF0050	6,9URD30TTF0050
	63	690	0.2	1.09	14	6,9URD30D11A0063	6,9URD30D08A0063	6,9URD30EF0063	6,9URD30TTF0063
	80	690	0.33	1.75	19	6,9URD30D11A0080	6,9URD30D08A0080	6,9URD30EF0080	6,9URD30TTF0080
	100	690	0.47	2.5	26	6,9URD30D11A0100	6,9URD30D08A0100	6,9URD30EF0100	6,9URD30TTF0100
	125	690	0.85	4.5	30	6,9URD30D11A0125	6,9URD30D08A0125	6,9URD30EF0125	6,9URD30TTF0125
	160	690	1.6	8.5	37	6,9URD30D11A0160	6,9URD30D08A0160	6,9URD30EF0160	6,9URD30TTF0160
	200	690	3	15.5	42/43	6,9URD30D11A0200	6,9URD30D08A0200	6,9URD30EF0200	6,9URD30TTF0200
	250	690	5.8	30	48/50	6,9URD30D11A0250	6,9URD30D08A0250	6,9URD30EF0250	6,9URD30TTF0250
	315	690	12	62	53/55	6,9URD30D11A0315	6,9URD30D08A0315	6,9URD30EF0315	6,9URD30TTF0315
	350	690	15.5	80	57/60	6,9URD30D11A0350	6,9URD30D08A0350	6,9URD30EF0350	6,9URD30TTF0350
	400	690	23	120	60/65	6,9URD30D11A0400	6,9URD30D08A0400	6,9URD30EF0400	6,9URD30TTF0400
	450	660	26	153	80/88	6,6URD30D11A0450	6,6URD30D08A0450	-	6,6URD30TTF0450
	500	660	41	245	80/88	6,6URD30D11A0500	6,6URD30D08A0500	-	6,6URD30TTF0500
550	660	52	305	80/90	6,6URD30D11A0550	6,6URD30D08A0550	-	6,6URD30TTF0550	
31	200	690	2.6	14	45	6,9URD31D11A0200	6,9URD31D08A0200	6,9URD31EF0200	6,9URD31TTF0200
	250	690	4.7	25	52	6,9URD31D11A0250	6,9URD31D08A0250	6,9URD31EF0250	6,9URD31TTF0250
	315	690	7.5	40	65	6,9URD31D11A0315	6,9URD31D08A0315	6,9URD31EF0315	6,9URD31TTF0315
	350	690	10.5	55	67	6,9URD31D11A0350	6,9URD31D08A0350	6,9URD31EF0350	6,9URD31TTF0350
	400	690	19	100	68	6,9URD31D11A0400	6,9URD31D08A0400	6,9URD31EF0400	6,9URD31TTF0400
	450	690	26.5	140	70	6,9URD31D11A0450	6,9URD31D08A0450	6,9URD31EF0450	6,9URD31TTF0450
	500	690	37	195	70/72	6,9URD31D11A0500	6,9URD31D08A0500	6,9URD31EF0500	6,9URD31TTF0500
	550	690	52	280	70/75	6,9URD31D11A0550	6,9URD31D08A0550	6,9URD31EF0550	6,9URD31TTF0550
	630	690	75	390	75/85	6,6URD31D11A0630	6,6URD31D08A0630	6,9URD31EF0630	6,9URD31TTF0630
	700	690	95	490	85/95	6,9URD31D11A0700	6,9URD31D08A0700	6,9URD31EF0700	6,9URD31TTF0700
800	660	140	815	105/120	6,6URD31D11A0800	6,6URD31D08A0800	-	6,6URD31TTF0800	
32	400	690	15	80	72/75	6,9URD32D11A0400	6,9URD32D08A0400	6,9URD32EF0400	6,9URD32TTF0400
	450	690	22	115	77/80	6,9URD32D11A0450	6,9URD32D08A0450	6,9URD32EF0450	6,9URD32TTF0450
	500	690	28	145	85/90	6,9URD32D11A0500	6,9URD32D08A0500	6,9URD32EF0500	6,9URD32TTF0500
	550	690	37	195	90/95	6,9URD32D11A0550	6,9URD32D08A0550	6,9URD32EF0550	6,9URD32TTF0550
	630	690	54	280	95/105	6,9URD32D11A0630	6,9URD32D08A0630	6,9URD32EF0630	6,9URD32TTF0630
	700	690	76	400	100/110	6,9URD32D11A0700	6,9URD32D08A0700	6,9URD32EF0700	6,9URD32TTF0700
	800	690	115	600	110/120	6,9URD32D11A0800	6,9URD32D08A0800	6,9URD32EF0800	6,9URD32TTF0800
	900	660	170	900	110/125	6,6URD32D11A0900	6,6URD32D08A0900	6,6URD32EF0900	6,6URD32TTF0900
	1000	660	240	1250	115/135	6,6URD32D11A1000	6,6URD32D08A1000	6,6URD32EF1000	6,6URD32TTF1000
	1100	600	270	1620	140/165	-	-	-	6URD32TTF1100
1250	500	410	1940	150/180	-	5URD32D08A1250	-	-	
33	500	690	19	100	105	6,9URD33D11A0500	6,9URD33D08A0500	6,9URD33EF0500	6,9URD33TTF0500
	550	690	27	140	105/110	6,9URD33D11A0550	6,9URD33D08A0550	6,9URD33EF0550	6,9URD33TTF0550
	630	690	40	130	110/120	6,9URD33D11A0630	6,9URD33D08A0630	6,9URD33EF0630	6,9URD33TTF0630
	700	690	55	300	115/125	6,9URD33D11A0700	6,9URD33D08A0700	6,9URD33EF0700	6,9URD33TTF0700
	800	690	95	490	120/130	6,9URD33D11A0800	6,9URD33D08A0800	6,9URD33EF0800	6,9URD33TTF0800
	900	690	135	700	120/135	6,9URD33D11A0900	6,9URD33D08A0900	6,9URD33EF0900	6,9URD33TTF0900
	1000	690	170	900	135/155	6,9URD33D11A1000	6,9URD33D08A1000	6,9URD33EF1000	6,9URD33TTF1000
	1100	690	240	1260	135/160	6,9URD33D11A1100	6,9URD33D08A1100	6,9URD33EF1100	6,9URD33TTF1100
	1250	660	350	1850	150/180	6,6URD33D11A1250	6,6URD33D08A1250	6,6URD33EF1250	6,6URD33TTF1250
	1400	660	480	2500	160/200	6,6URD33D11A1400	6,6URD33D08A1400	6,6URD33EF1400	6,6URD33TTF1400
	1500	600	500		220	6URD33D11A1500	6,6URD33D08A1500	-	6URD33TTF1500
	1600	600	555		210/240	6URD33D11A1600	6URD33D08A1600	-	6URD33TTF1600
	1800	600	720		225/260	6URD33D11A1800	6URD33D08A1800	-	6URD33TTF1800
	2000	550	950		250/290	-	-	-	5,5URD33TTF2000
	2250	500	1250		280/330	-	-	-	5URD33TTF2250
	2500	450	1870		280/330	-	-	-	4,5URD33TTF2500

** Watts loss data is published for both blade and tapped style mounting configurations. When two watts loss values are shown this represents tapped/blade values respectively.

690/700 Volt

SEMICONDUCTOR PROTECTION FUSES

700 Volt North American Style Ratings and Application Data

Body Size	Amp Rating	Rated Voltage	Melting I ² t (A ² s x 10 ³)	Total I ² t @ Rated Voltage (A ² s x 10 ³)	**Watts Loss @ Rated Current (W)	Long Blade Catalog No. Type LI	Short Blade Catalog No. Type KI	Tapped Terminal Catalog No. Type TTI
30	63	700	0.2	1.2	14	A070URD30LI0063	A070URD30KI0063	A070URD30TTI0063
	80	700	0.33	1.9	19	A070URD30LI0080	A070URD30KI0080	A070URD30TTI0080
	100	700	.47	2.7	26	A070URD30LI0100	A070URD30KI0100	A070URD30TTI0100
	125	700	0.85	4.9	30	A070URD30LI0125	A070URD30KI0125	A070URD30TTI0125
	160	700	1.6	9.2	37	A070URD30LI0160	A070URD30KI0160	A070URD30TTI0160
	200	700	3	16.7	42/43	A070URD30LI0200	A070URD30KI0200	A070URD30TTI0200
	250	700	5.8	32.4	48/50	A070URD30LI0250	A070URD30KI0250	A070URD30TTI0250
	315	700	12	67	53/55	A070URD30LI0315	A070URD30KI0315	A070URD30TTI0315
	350	700	15.5	86	57/60	A070URD30LI0350	A070URD30KI0350	A070URD30TTI0350
	400	700	23	130	60/65	A070URD30LI0400	A070URD30KI0400	A070URD30TTI0400
	450	700	26	165	80/88	A070URD30LI0450	A070URD30KI0450	A070URD30TTI0450
	500	700	41	264	80/88	A070URD30LI0500	A070URD30KI0500	A070URD30TTI0500
550	700	52	330	80/90	A070URD30LI0550	A070URD30KI0550	A070URD30TTI0550	
31	200	700	2.5	14.6	45	A070URD31LI0200	A070URD31KI0200	A070URD31TTI0200
	250	700	4.7	27	52	A070URD31LI0250	A070URD31KI0250	A070URD31TTI0250
	315	700	7.5	43	65	A070URD31LI0315	A070URD31KI0315	A070URD31TTI0315
	350	700	10.5	59	67	A070URD31LI0350	A070URD31KI0350	A070URD31TTI0350
	400	700	19	110	68	A070URD31LI0400	A070URD31KI0400	A070URD31TTI0400
	450	700	26.5	150	70	A070URD31LI0450	A070URD31KI0450	A070URD31TTI0450
	500	700	37	210	70/72	A070URD31LI0500	A070URD31KI0500	A070URD31TTI0500
	550	700	52	300	70/75	A070URD31LI0550	A070URD31KI0550	A070URD31TTI0550
	630	700	75	421	75/85	A070URD31LI0630	A070URD31KI0630	A070URD31TTI0630
700	700	95	530	85/95	A070URD31LI0700	A070URD31KI0700	A070URD31TTI0700	
800	700	140	880	105/120	A070URD31LI0800	A070URD31KI0800	A070URD31TTI0800	
32	400	700	15	86	72/75	A070URD32LI0400	A070URD32KI0400	A070URD32TTI0400
	450	700	22	124	77/80	A070URD32LI0450	A070URD32KI0450	A070URD32TTI0450
	500	700	28	157	85/90	A070URD32LI0500	A070URD32KI0500	A070URD32TTI0500
	550	700	37	211	90/95	A070URD32LI0550	A070URD32KI0550	A070URD32TTI0550
	630	700	54	302	95/105	A070URD32LI0630	A070URD32KI0630	A070URD32TTI0630
	700	700	76	432	100/110	A070URD32LI0700	A070URD32KI0700	A070URD32TTI0700
	800	700	115	648	110/120	A070URD32LI0800	A070URD32KI0800	A070URD32TTI0800
	900	700	170	972	110/125	A070URD32LI900	A070URD32KI900	A070URD32TTI900
	1000	700	240	1350	115/135	A070URD32LI1000	A070URD32KI1000	A070URD32TTI1000
	1100	650	270	1620	140/165	A065URD32LI1100	-	A065URD32TTI1100
	1250	600	410	2100	150/180	A060URD32LI1250	-	A060URD32TTI1250
	1400	550	555	2600	160/190	A055URD32LI1400	-	A055URD32TTI1400
	1600	550	870	4000	165/195	A055URD32LI1600	-	A055URD32TTI1600
1800	500	1050	4400	195/330	A050URD32LI1800	-	A050URD32TTI1800	
33	500	700	19	108	105	A070URD33LI0500	A070URD33KI0500	A070URD33TTI0500
	550	700	27	151	105/110	A070URD33LI0550	A070URD33KI0550	A070URD33TTI0550
	630	700	40	227	110/120	A070URD33LI0630	A070URD33KI0630	A070URD33TTI0630
	700	700	55	324	115/125	A070URD33LI0700	A070URD33KI0700	A070URD33TTI0700
	800	700	95	529	120/130	A070URD33LI0800	A070URD33KI0800	A070URD33TTI0800
	900	700	135	760	120/135	A070URD33LI0900	A070URD33KI0900	A070URD33TTI0900
	1000	700	170	970	135/155	A070URD33LI1000	A070URD33KI1000	A070URD33TTI1000
	1100	700	240	1360	135/160	A070URD33LI1100	A070URD33KI1100	A070URD33TTI1100
	1250	700	350	2000	150/180	A070URD33LI1250	A070URD33KI1250	A070URD33TTI1250
	1400	700	480	2700	160/200	A070URD33LI1400	A070URD33KI1400	A070URD33TTI1400
	1600	650	555	3250	210/240	A065URD33LI1600	A065URD33KI1600	A065URD33TTI1600
	1800	650	720	4330	225/260	A065URD33LI1800	-	A065URD33TTI1800
	2000	600	950	5000	250/290	A060URD33LI2000	-	A060URD33TTI2000
	2250	550	1250	5900	280/330	A055URD33LI2250	-	A055URD33TTI2250
	2500	500	1870	7600	280/330	A050URD33LI2500	-	A050URD33TTI2500

** Watts loss data is published for both blade and tapped style mounting configurations.
When two watts loss values are shown this represents tapped/blade values respectively.



A070 URD 30 & 6,9 URD 30 63 to 400A

Melting Time — Current Data

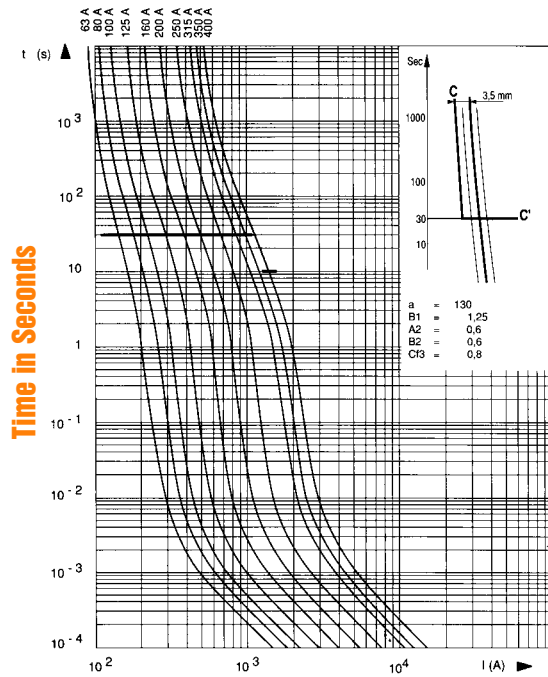

Current in Amperes

Peak Let-Thru Current Data

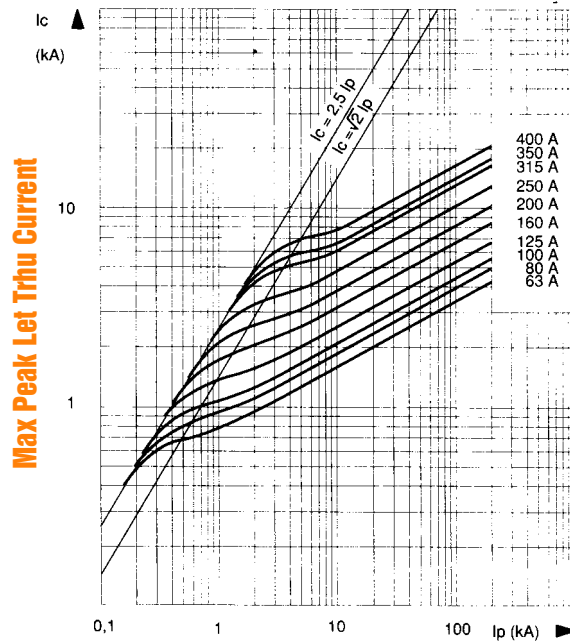

Available Current in RMS Symmetrical Amperes

A070 URD 31 & 6,9 URD 31 200 to 700A

Melting Time — Current Data

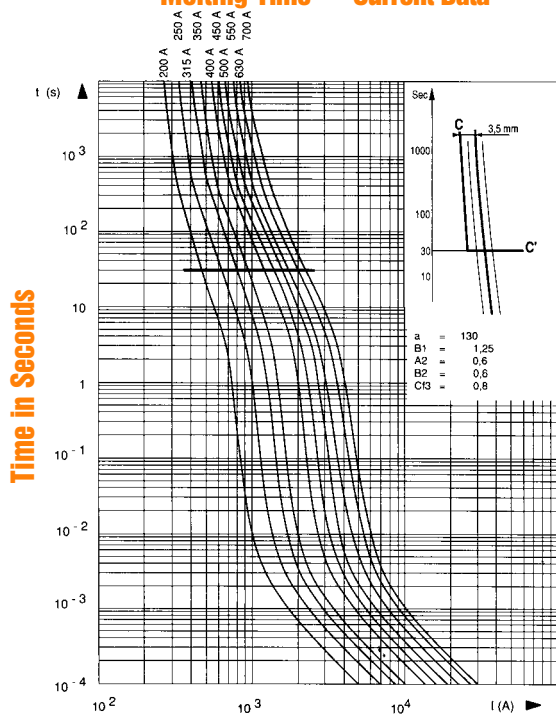

Current in Amperes

Peak Let-Thru Current Data

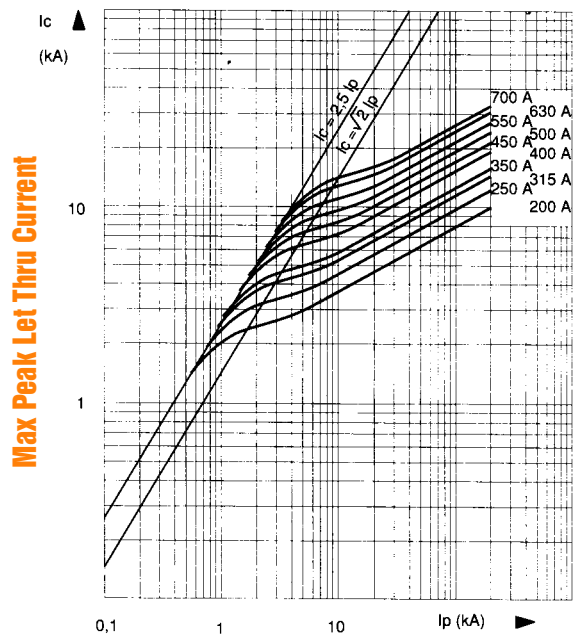

Available Current in RMS Symmetrical Amperes

PSC

690/700 Volt

SEMICONDUCTOR PROTECTION FUSES



A070 URD 32 & 6,9 URD 32 400 to 1000A

Melting Time — Current Data

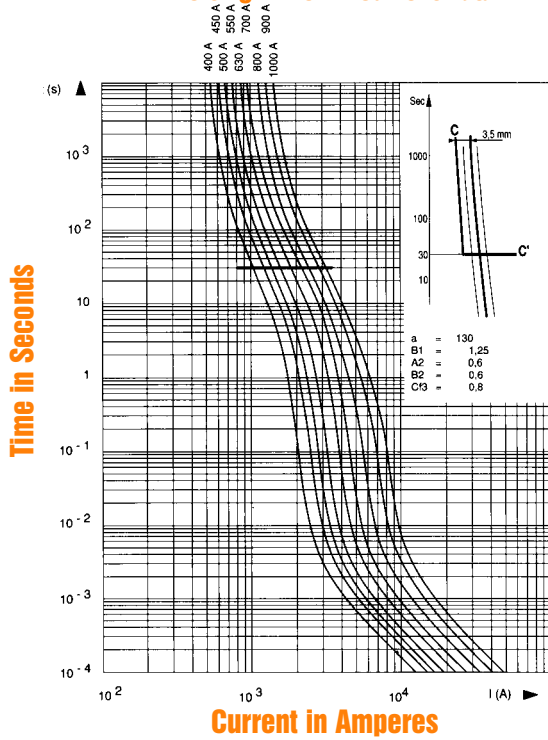

Peak Let-Thru Current Data

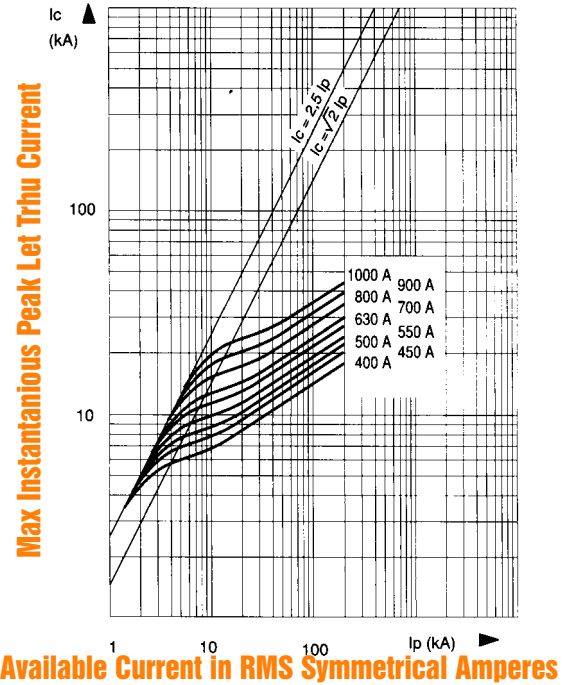

A070 URD 33 & 6,9 URD 33 500 to 1400A

Melting Time — Current Data

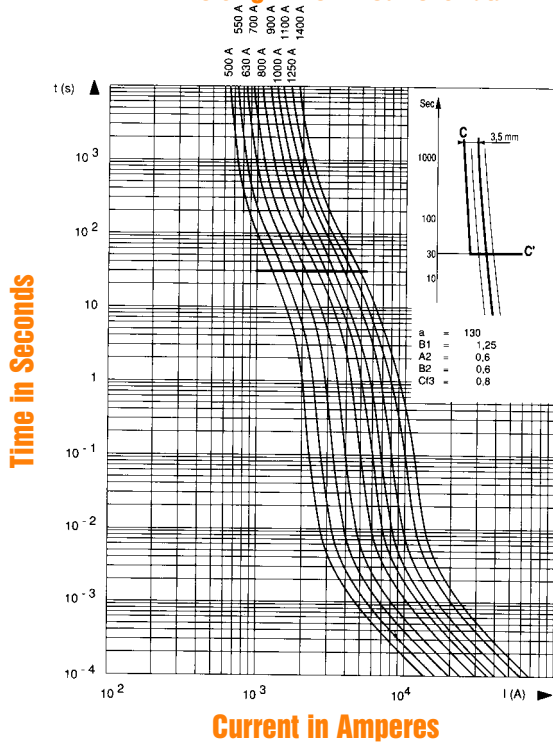

Peak Let-Thru Current Data

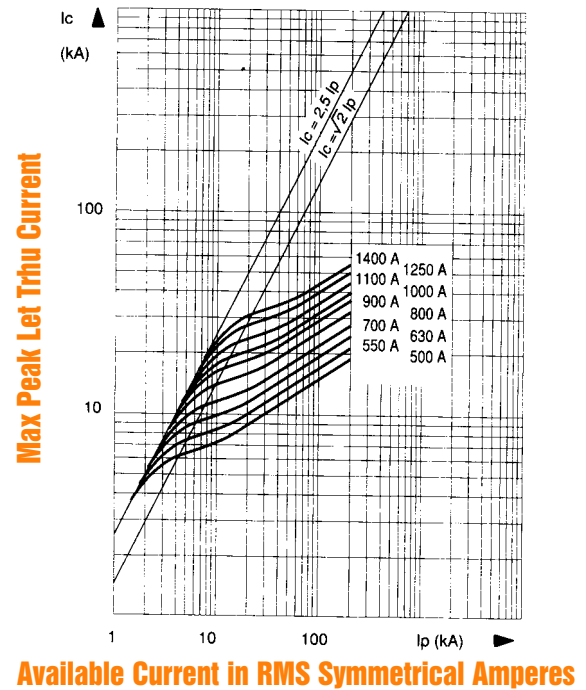

PSC

690/700 Volt

SEMICONDUCTOR PROTECTION FUSES

Application Information-All Sizes

Watts Loss vs. % Rated Current

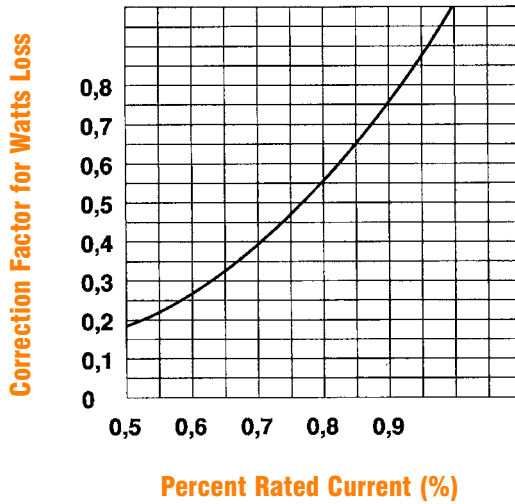

Correction factor to determine the watts loss value of a fuse operating below its rated current

Clearing I²t vs. Operating Voltage

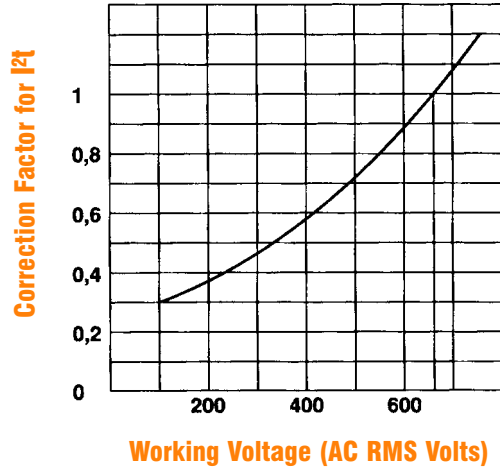

Correction factor to determine the clearing I²t value for a fuse operating below its rated voltage

Maximum Arc Volts vs. System Voltage

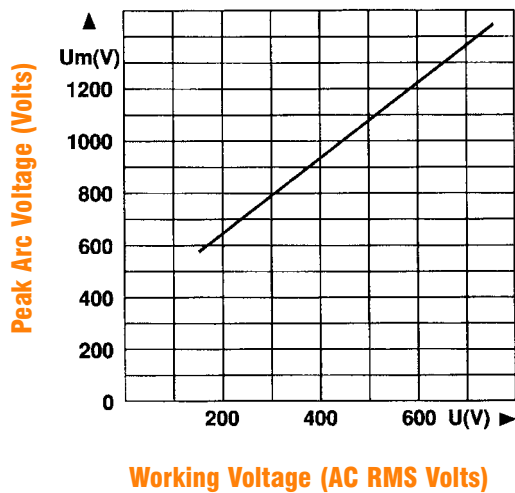

Determines the peak arc voltage across the fuse terminals as a function of the applied voltage

Ampere Rating Correction Factor vs. Air Flow Speed

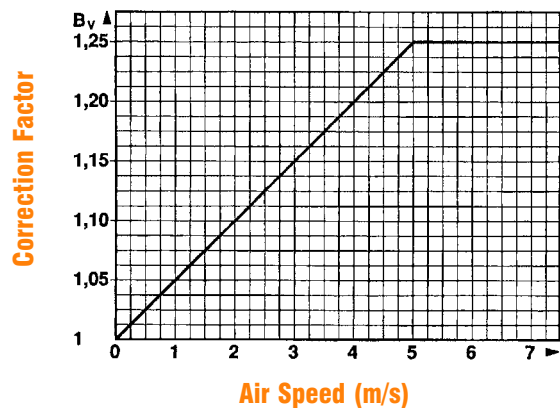

Determines the current carrying correction factor based on the cooling air speed across the fuse

Application Information Cont.-All Sizes

DC Voltage Capability vs. Time Constant

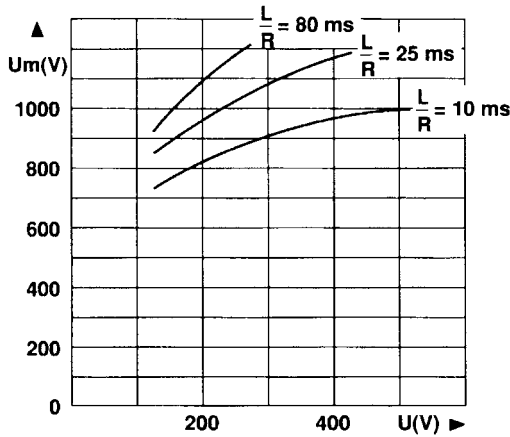
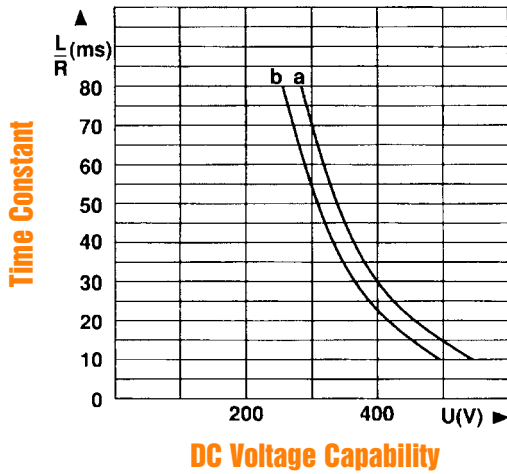

Provides the DC Voltage capability of the fuse as a function of circuit time constant (L/R ratio).

*Consult Factory for DC capabilities on ampere ratings not shown.

Rated current I_N (A)	Curves (*) and I_{pm} (†) corresponding to the rating					
	30 * I_{pm} (A)	31 * I_{pm} (A)	32 * I_{pm} (A)	33 * I_{pm} (A)	2x32 * I_{pm} (A)	2x33 * I_{pm} (A)
63	a 230					
80	a 300					
100	a 360					
125	a 460					
160	a 650					
200	a 880	a 850				
250	a 1300	a 1150				
315	a 1700	a 1450				
350	a 1900	a 1600				
400	a 2300	a 2200	a 2000			
450		a 2500	a 2300			
500		a 3000	a 2600	a 2300		
550		a 3400	a 3150	a 2500		
630		a 5000	a 3700	a 3250		
700		a 5600	a 4300	a 3900		
800			a 5300	a 4800		
900			a 7800	a 5600		
1000			b 9000	a 6600	a 5200	
1100				a 7700		
1250				b 11000	a 7400	a 6500
1400				b 12500	a 8600	a 7800
1600					a 10600	a 9600
1800					a 15600	a 11200
2000					b 18000	a 13200
2200						a 15400
2500						b 22000
2800						b 25000



PSC SQUARE BODY

690/700 VOLT 2X32, 2X33

SEMICONDUCTOR PROTECTION FUSES

SIZE	CATALOG NO.					REF #	WEIGHT (g)
2 x 32	6,9	URD	232	TTF	1000	T300213	1240
	6,9	URD	232	TTF	1250	V300214	
	6,9	URD	232	TTF	1400	G300087	
	6,6	URD	232	TDF	1600	W300215	3300
	6,6	URD	232	TDF	1800	X300216	
	6,6	URD	232	TDF	2000	Y300217	
2 x 33	5,5	URD	232	TDF	2200	D301993	1900
	6,9	URD	233	TTF	1250	D300268	
	6,9	URD	233	TTF	1400	E300269	
	6,9	URD	233	TTF	1600	F300270	2000
	6,9	URD	233	PLAF	1800	B300427	
	6	URD	233	PLAF	2000	R302235	
	6	URD	233	PLAF	2200	Q302234	
	6	URD	233	PLAF	2500	D300429	
	6	URD	233	PLAF	2800	F300431	
	5,5	URD	233	PLAF	3000	L301977	
	5,5	URD	233	PLAF	3200	M301978	
	5	URD	233	PLAF	3600	N301979	
	5	URD	233	PLAF	4000	P301980	
	4	URD	233	PLAF	4500	Q301981	
4	URD	233	PLAF	5000	R301982		

Dimensions in mm

SIZE	A	B	C	D	E	F	G	H	J	K	d	e	L	M	N
2x32 TT	60	138,5	172	11	67,6	66,5	100	35	61	40	M 10	4	107,5	48	72
2x33 TT	74,5	167	200	13	67,6	81	114	50	80	40	M 12	4	107,5	54	86
2x32 TD	65,5	147	182	-	91,5	-	-	30	-	60	M 10	12	140	-	-
2x33 PLAF	75	171,5	207	-	55,5	-	115	40	-	71	M 10	15	81	-	-

TT

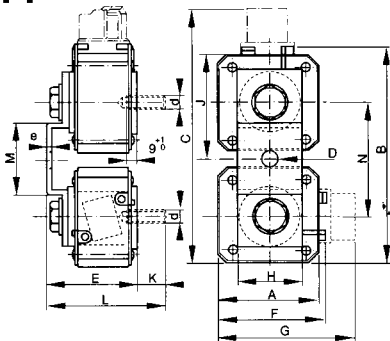

TD

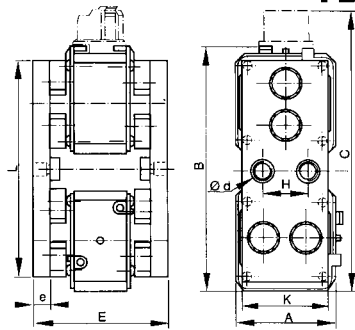

PLAF

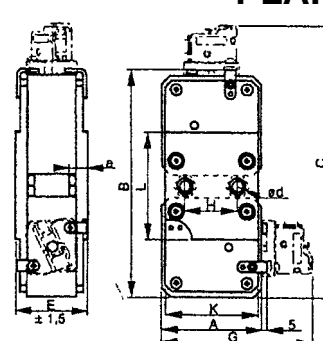

Studs and microswitches supplied separately

33 PPAF Standard Press-Pack



SIZE	CATALOG NO.				REF #	WEIGHT (g)	PACK.
33	6,9	URD	33	PPAF	1250	-	910
	6,9	URD	33	PPAF	1400	-	

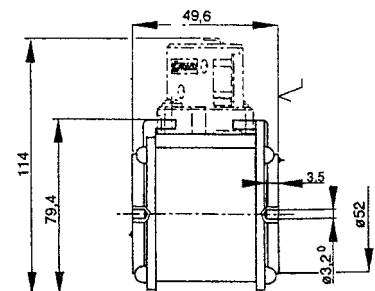

690/700 Volt 2X32 SEMICONDUCTOR PROTECTION FUSES

Melting Time Current Data 2X32

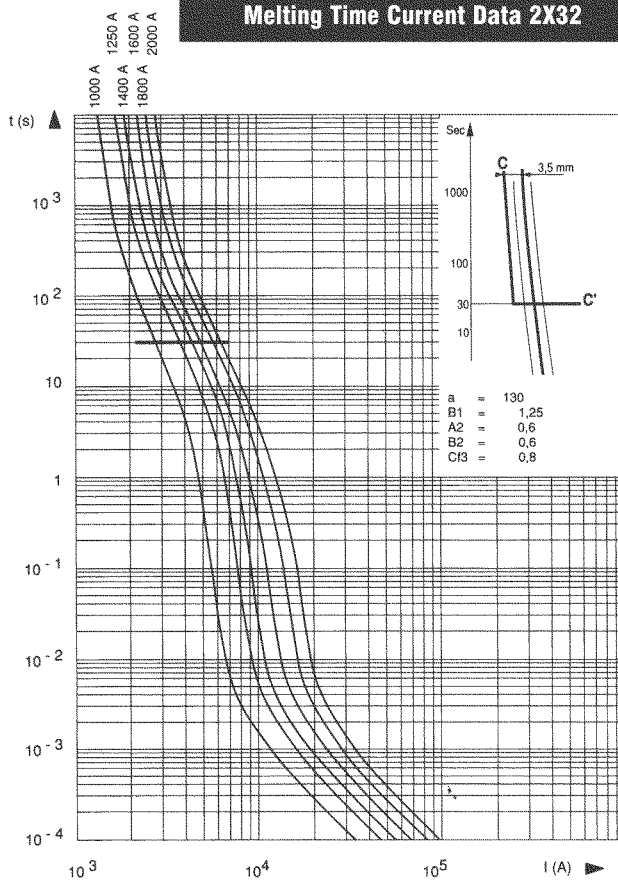

Peak let-thru Data 2X32

Below, right: Curves indicating for each rated current the peak value I_c that the current may reach as function of the prospective fault current I_p .

Taille
Size 2 x 32
Größe

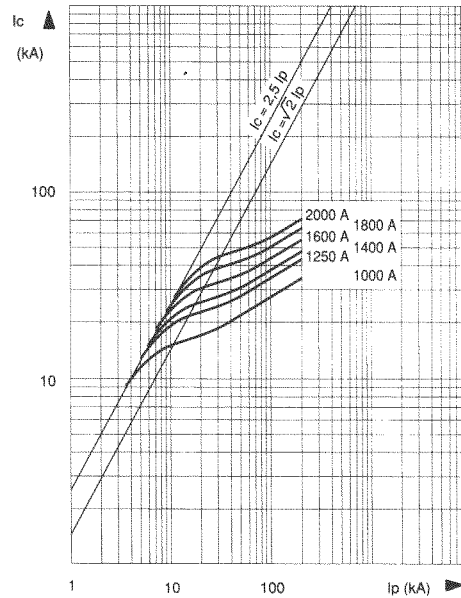

Clearing I²t Data 2X32

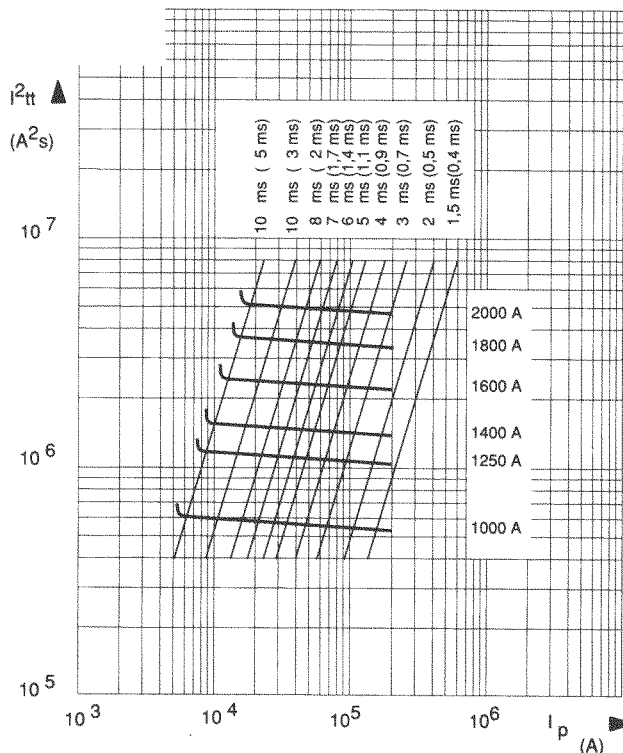

Time-current characteristics

- Above, left: Curves indicating pre-arcing time for each rated current as a function of RMS value of pre-arcing current I .
- Tolerances on this current = 8%.
- Beyond 30 sec or 10 sec, small overloads must be eliminated by another device
- Curve CC' represents the maximum times taken by the associated device to clear small overloads; only its horizontal line is represented. Its oblique line must be plotted according to sketch, top right corner.
- The intersection of the fuse and CC' curves indicates the minimum breaking current I_{pm} of the fuse.

Maximum values of total operating I²t and total operating times

- Left: Horizontal curves indicating the maximum values of total operating I^2t (I^2t_t) as function of the prospective current I_p at 660 V, $\cos w = 0.15$.
- The oblique lines indicate the corresponding total operating time T_t , with pre-arcing time in brackets.



690/700 Volt 2X33 SEMICONDUCTOR PROTECTION FUSES

Melting Time Current Data 2X33

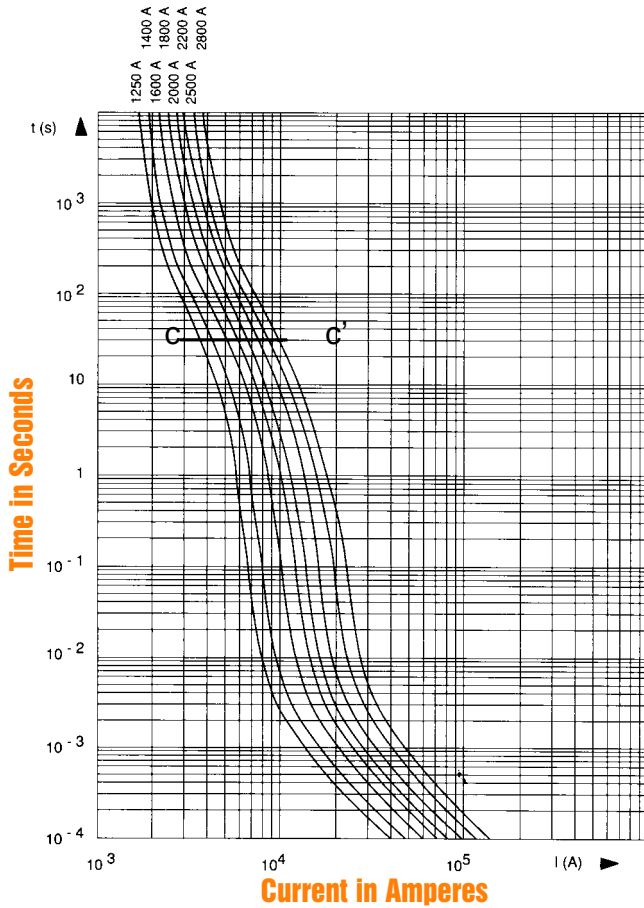

Peak let-thru Data 2X33

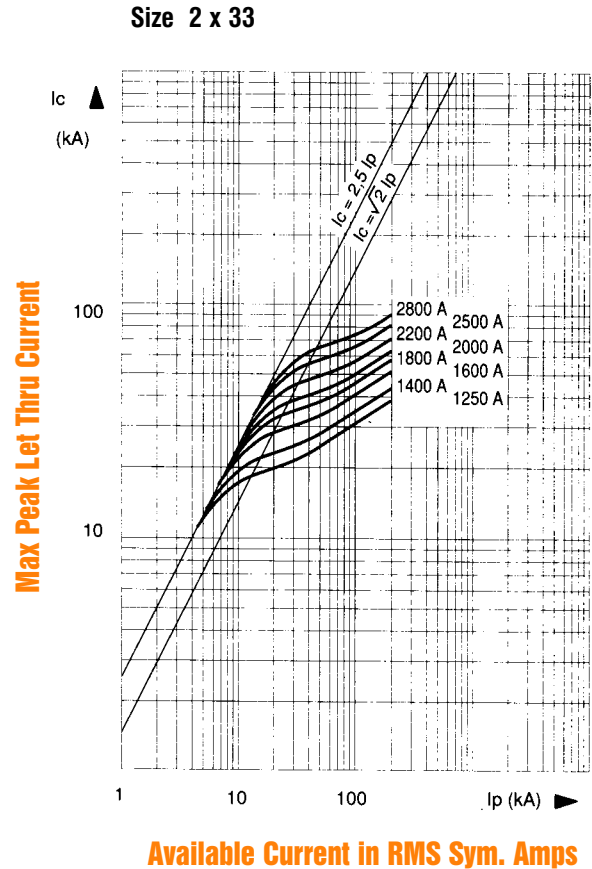

Clearing I^2t Data 2X33

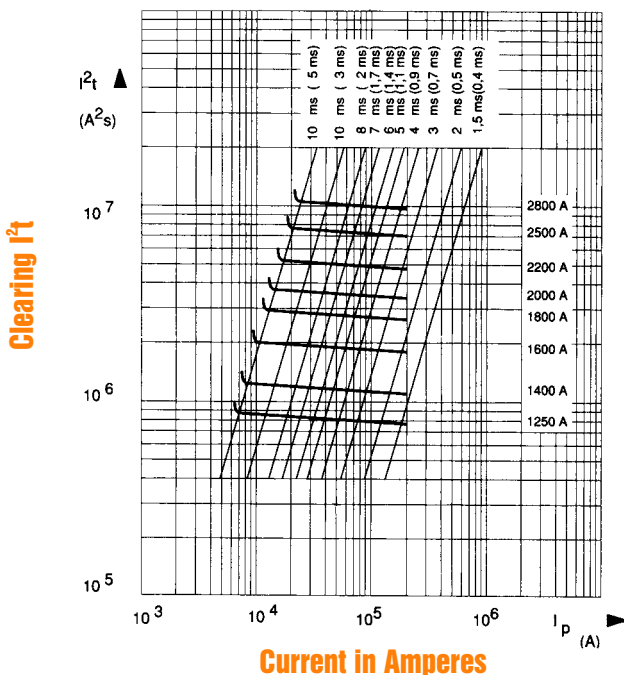

Time-current characteristics

Above, left: Curves indicating pre-arcing time for each rated current as a function of RMS value of pre-arcing current I .

- Tolerances on this current $\pm 8\%$.
- Beyond 30 sec small overloads must be eliminated by another device
- The intersection of the fuse and CC' curves indicates the minimum breaking current of the fuse.

Maximum values of total clearing I^2t and total operating times

Left: Horizontal curves indicating the maximum values of total operating I^2t as function of the prospective current I_p at 660 V, $\cos w = 0.15$.

The vertical lines indicate the corresponding total clearing time T_t , with melting time in brackets.