

PSC SQUARE BODY

1250/1300 Volt

SEMICONDUCTOR PROTECTION FUSES



Ferraz Shawmut 1250/1300V PSC fuse-links provide maximum flexibility in equipment design and ultimate protection for today's power conversion equipment. These square body fuse-links are available in four different body sizes, each size having four world-wide acceptable mounting styles. The different mounting styles and body sizes along with a broad range of ampere ratings allow greatest flexibility in equipment design.

The Ferraz Shawmut PSC fuses have been engineered to provide state-of-the-art protection for SCR's, diodes, thyristors, GTO's and IGBT devices. They have pure silver die-cut elements embedded in solidified sand which helps control arcing characteristics for low I²t and high interrupting rating. All contact surfaces are silver plated and all hardware is non-magnetic.

All fuse links are equipped with a low voltage trip-indicator. This trip-indicator can operate a field mountable microswitch which is easily mounted directly onto the fuse even while in service.



HIGHLIGHTS:

- Extremely Fast Acting
- Current Limiting
- Very Low I²t
- Worldwide Acceptability
- Superior Cycling Ability

APPLICATIONS:

- Protection of rectifiers, inverters, DC drives, UPS Systems, reduced voltage motor starters, and other equipment in globally accepted applications

Features/Benefits

- **Choice of mounting styles** gives wide choice for equipment design
- **Broad range of ampere ratings** in a given body size for design flexibility
- **IEC 269-4 compliance** for fuses for worldwide semiconductor applications

Ratings

- **AC:** 50-1800A
650-1300 VAC
100 kA IR
- **DC:** Consult Factory

Approvals

- UL Recognized Component
- Sizes 70,71,72,73 tested to IEC 269.4

*For Microswitch information see page J10



Part Number Designation:

12,5URD:	European/IEC Mounting Style/Approval Tested @ 1.1 V _N
A130URD:	North American Mounting Style/Approval Tested @ V _N

*V_N = rated voltage

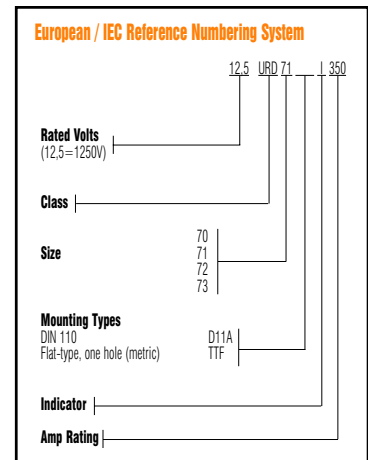
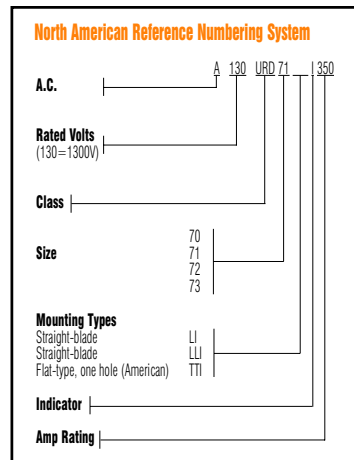

1250/1300 Volt SEMICONDUCTOR PROTECTION FUSES

Outline Dimensions

Type D11A

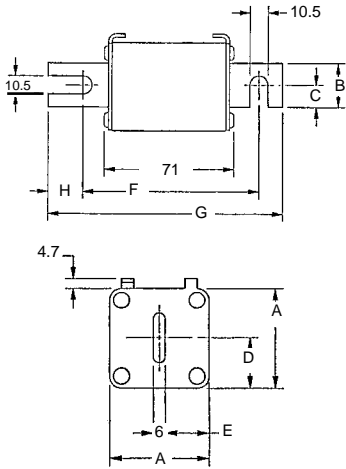

European Blade DIN 110, Type D11A

CATALOG NO.	DIMENSIONS - mm						
	A	B	C	D	E	F	G
12,5 URD 70 D11A (50-250) 12 URD 70 D11A (280-315) 11 URD 70 D11A (350-400)	40	25	12.5	21	17	100.4	133.4
12,5 URD 71 D11A (160-450) 11 URD 71 D11A (500-550) 10 URD 71 D11A 630	51	25	12.5	25.5	22.5	100.4	133.4
12,5 URD 72 D11A (280-550) 11 URD 72 D11A 630 10 URD 71 D11A (700-900)	60	32	16	30	27	100.4	133.4
12,5 URD 73 D11A (315-630) 12 URD 73 D11A 700 11 URD 73 D11A 800 10 URD 73 D11A 900 9 URD 73 D11A 1100	74.5	40	20	37.2	34.25	100.4	133.4

Types LI and LLI

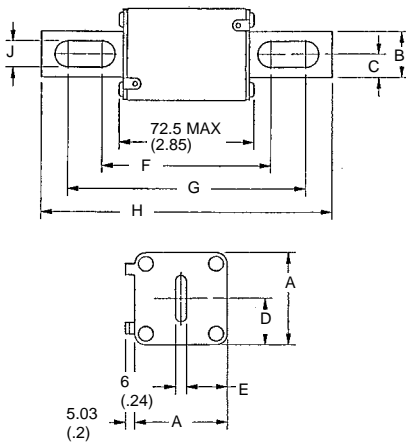

North American Straight Blade, Types LI & LLI

CATALOG NO.	DIMENSIONS - mm/(in)									
	A	B	C	D	E	F	G	H	J	
A130 URD 70 LI (63-315) A120 URD 70 LI 350	40 (1.57)	25 (0.98)	12.5 (0.49)	21 (0.83)	18 (0.71)	91.4 (3.60)	130.4 (5.13)	152.4 (6.00)	10.5 (0.41)	
A130 URD 71 LLI (160-450) A120 URD 71 LLI (500-550) A110 URD 71 LLI 630	51 (2.01)	25 (0.98)	12.5 (0.49)	25.5 (1.00)	22.5 (0.89)	91.4 (3.60)	130.4 (5.13)	152.4 (6.00)	14.6 (0.57)	
A130 URD 72 LI (280-550) A120 URD 72 LI (800) A110 URD 72 LI (700-800)	60 (2.36)	32 (1.26)	16 (0.63)	30 (1.18)	27 (1.06)	97.6 (3.84)	132.4 (5.2)	157.4 (6.20)	14.6 (0.57)	
A130 URD 73 LI (315-700) A120 URD 73 LI (800) A110 URD 73 LI (900-1000) A090 URD 73 LI (1400) A070 URD 73 LI 1600 A065 URD 73 LI 1800	74.5 (2.93)	40 (1.57)	20 (0.79)	37.2 (1.46)	34.2 (1.35)	98.8 (3.89)	132.4 (5.21)	157.4 (6.20)	15.9 (0.63)	

Types TTI and TTF

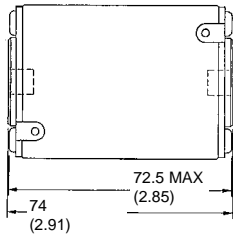
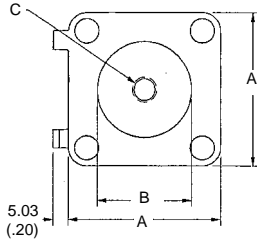

North American Flat Single Hole, Type TTI

CATALOG NO.	DIMENSIONS - In/(mm)		
	A	B	C
A130 URD 70 TTI (63-315) A120 URD 70 TTI 350	1.57 (40)	1.00 (25.4)	5/16-18 x .23 DP
A130 URD 71 TTI (160-450) A120 URD 71 TTI (550-630)	2.01 (51)	1.19 (30.2)	5/16-18 x .36 DP
A130 URD 72 TTI (280-630) A120 URD 72 TTI (700-800)	2.36 (60)	1.50 (38.1)	3/8-16 x .36 DP
A130 URD 73 TTI (315-900) A110 URD 73 TTI (1000) A100 URD 73 TTI (1250) A090 URD 73 TTI (1400) A070 URD 73 TTI (1600) A065 URD 73 TTI (1800)	2.93 (74.5)	1.81 (46)	1/2-13 x .36 DP

European Flat Single Hole, Type TTF

CATALOG NO.	DIMENSIONS - In/(mm)		
	A	B	C
12,5 URD 70 TTF (050-315) 11 URD 70 TTF (350-400)	40	26	M8 x 1.25 x 9 DP
12,5 URD 71 TTF (160-450) 11 URD 71 TTF (350-400)	51	30	M8 x 1.25 x 9 DP
12,5 URD 72 TTF (280-630) 11 URD 72 TTF (700-800) 10 URD 72 TTF (900) 8,5 URD 72 TTF (1000)	60	38	M10 x 1.5 x 9 DP
12,5 URD 73 TTF (315-800) 12 URD 73 TTF (0900) 10 URD 73 TTF (1000) 9,5 URD 73 TTF (1100) 9 URD 73 TTF (1250) 8,5 URD 73 TTF (1400) 6,6 URD 73 TTF (1600) 6 URD 73 TTF (1800)	74.5	46	M12 x 1.75 x 9 DP



Standard Threaded Studs

SIZE	REF. AND DIMENSION PER PAIR OF STUDS	WEIGHT (g)	MAX STUD MOUNTING TORQUE (Nm)	MAX NUT TIGHTENING TORQUE (Nm)		
				FIG1	FIG 2	FIG 3
70 & 71	S 98 801 (HC M8 X 30 & M 8 X 35)	23	13	13.5	13.5	13.5
72	T 98 802 (HC M 10 X 30 & M 10 X 50)	40				
73	V 98 803 (HC M 12 X 35 & M 12 X 50)	60	15	46	46	15
2X72	W 98 804 (HC M 10 X 50)	50				
2X73	X 98 805 (HC M 12 X 50)	70				

Packaging: 6 pairs

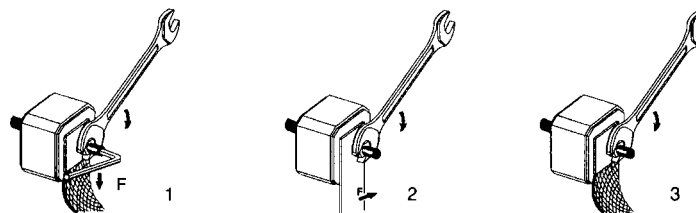

1250/1300 Volt SEMICONDUCTOR PROTECTION FUSES

1250 Volt European/IEC Style Ratings and Application Data

Body Size	Amp Rating	Rated Voltage	Melting I ² t (A ² s x 10 ³)	Total I ² t @ Rated Voltage (A ² s x 10 ³)	**Watts Loss @ Rated Current (W)	DIN 110 Catalog No. Type D11A	Metric Tapped Single Catalog No. Type TTF
70	50	1250	0.116	0.98	16	12,5URD70D11A0050	12,5URD70TTF0050
	63	1250	0.21	1.7	26	12,5URD70D11A0063	12,5URD70TTF0063
	80	1250	0.47	3.8	27	12,5URD70D11A0080	12,5URD70TTF0080
	100	1250	0.83	6.7	30	12,5URD70D11A0100	12,5URD70TTF0100
	125	1250	1.3	10.5	38	12,5URD70D11A0125	12,5URD70TTF0125
	160	1250	2.55	21	45	12,5URD70D11A0160	12,5URD70TTF0160
	200	1250	4.7	37.8	54/56	12,5URD70D11A0200	12,5URD70TTF0200
	250	1250	9.6	77	58/61	12,5URD70D11A0250	12,5URD70TTF0250
	280	1200	14	107	61	12URD70D11A0280	-
	280	1250	14	107	64	-	12,5URD70TTF0280
	315	1200	20	150	66	12URD70D11A0315	-
	315	1250	20	150	72	-	12,5URD70TTF0315
350	1100	28	180	68/75	11URD70D11A0350	11URD70TTF0350	
400	1100	39	254	81	11URD70D11A0400	11URD70TTF0400	
71	160	1250	2.6	21	46	12,5URD71D11A0160	12,5URD71TTF0160
	200	1250	4.7	38	54	12,5URD71D11A0200	12,5URD71TTF0200
	250	1250	8.9	71	61	12,5URD71D11A0250	12,5URD71TTF0250
	315	1250	16	130	73/76	12,5URD71D11A0315	12,5URD71TTF0315
	350	1250	22	180	76/80	12,5URD71D11A0350	12,5URD71TTF0350
	400	1250	38	310	76/80	12,5URD71D11A0400	12,5URD71TTF0400
	450	1250	47	380	87/95	12,5URD71D11A0450	12,5URD71TTF0450
	500	1100	68	440	90/100	11URD71D11A0500	11URD71TTF0500
	550	1100	84	540	98/112	11URD71D11A0550	11URD71TTF0550
	630	1000	125	810	105	10URD71D11A0630	-
630	1100	125	810	120	-	11URD71TTF0630	
72	280	1250	10	84	72	12,5URD72D11A0280	12,5URD72TTF0280
	315	1250	15	122	76	12,5URD72D11A0315	12,5URD72TTF0315
	350	1250	21	170	77	12,5URD72D11A0350	12,5URD72TTF0350
	400	1250	32.5	270	80	12,5URD72D11A0400	12,5URD72TTF0400
	450	1250	44	360	87/89	12,5URD72D11A0450	12,5URD72TTF0450
	500	1250	57	460	94/98	12,5URD72D11A0500	12,5URD72TTF0500
	550	1250	68	550	110/120	12,5URD72D11A0550	12,5URD72TTF0550
	630	1100	105	850	113	11URD72D11A0630	-
	630	1250	105	850	125	-	12,5URD72TTF0630
	700	1000	145	910	122	10URD72D11A0700	-
	700	1100	145	910	140	-	11URD72TTF0700
	800	1000	215	1400	125	10URD72D11A0800	-
	800	1100	215	1400	146	-	11URD72TTF0800
900	1000	312	1800	130	10URD72D11A0900	10URD72TTF0900	
1000	850	-	-	136	-	8,5URD72TTF1000	
73	315	1250	12	95	84	12,5URD73D11A0315	12,5URD73TTF0315
	350	1250	17	140	86	12,5URD73D11A0350	12,5URD73TTF0350
	400	1250	25	200	93	12,5URD73D11A0400	12,5URD73TTF0400
	450	1250	35.5	290	99/100	12,5URD73D11A0450	12,5URD73TTF0450
	500	1250	44	360	110/112	12,5URD73D11A0500	12,5URD73TTF0500
	550	1250	57	460	116/120	12,5URD73D11A0550	12,5URD73TTF0550
	630	1250	84	680	125/132	12,5URD73D11A0630	12,5URD73TTF0630
	700	1200	110	900	135	12URD73D11A0700	-
	700	1250	110	900	146	-	12,5URD73TTF0700
	800	1100	190	1530	136	11URD73D11A0800	-
	800	1250	190	1530	148	-	12,5URD73TTF0800
	900	1000	250	1870	150	10URD73D11A0900	-
	900	1200	250	1870	170	-	12URD73TTF0900
	1000	900	370	2130	152	9URD73D11A1000	-
	1000	1000	370	2130	174	-	10URD73TTF1000
	1100	900	445	2470	168	9URD73D11A1100	-
	1100	950	445	2470	208	-	9,5URD73TTF1100
	1250	900	585	3050	186/200	-	9URD73TTF1250
1400	850	755	3700	210/228	-	8,5URD73TTF1400	
1600	660	1430	5630	203	-	6,6URD73TTF1600	
1800	600	2040	7600	206	-	6URD73TTF1800	

** Watts loss data is published for both blade and tapped style mounting configurations. When two watts loss values are shown this represents tapped/blade values respectively.

1250/1300 Volt SEMICONDUCTOR PROTECTION FUSES

1300 Volt North American Style Ratings and Application Data

Body Size	Amp Rating	Rated Voltage	Melting I ² t (A ² s x 10 ³)	Total I ² t @ Rated Voltage (A ² s x 10 ³)	**Watts Loss @ Rated Current (W)	N.American Blade Catalog No. Type LI	Tapped Single Catalog No. Type TTI
70	63	1300	0.21	1.8	26	A130URD70LI0063	A130URD70TTI0063
	80	1300	0.47	4	27	A130URD70LI0080	A130URD70TTI0080
	100	1300	0.83	7.2	30	A130URD70LI0100	A130URD70TTI0100
	125	1300	1.3	11	38	A130URD70LI0125	A130URD70TTI0125
	160	1300	2.5	22	45	A130URD70LI0160	A130URD70TTI0160
	200	1300	4.7	40	54/56	A130URD70LI0200	A130URD70TTI0200
	250	1300	9.6	82	58/61	A130URD70LI0250	A130URD70TTI0250
	315	1300	20	172	66/72	A130URD70LI0315	A130URD70TTI0315
	350	1200	28	205	68/75	A120URD70LI0350	A120URD70TTI0350
71	160	1300	2.6	22	46	A130URD71LLI0160	A130URD71TTI0160
	200	1300	4.7	40	54	A130URD71LLI0200	A130URD71TTI0200
	250	1300	8.9	76	61	A130URD71LLI0250	A130URD71TTI0250
	280	1300	12	102	68/70	A130URD71LLI0280	A130URD71TTI0280
	315	1300	16	138	73/76	A130URD71LLI0315	A130URD71TTI0315
	350	1300	22	190	76/80	A130URD71LLI0350	A130URD71TTI0350
	400	1300	38	330	76/80	A130URD71LLI0400	A130URD71TTI0400
	450	1300	47	405	87/95	A130URD71LLI0450	A130URD71TTI0450
	500	1200	68	500	90/100	A120URD71LLI0500	A120URD71TTI0500
	550	1200	84	620	98/112	A120URD71LLI0550	A120URD71TTI0550
	630	1100	125	930	105	A110URD71LLI0630	-
630	1200	125	930	120	-	A120URD71TTI0630	
72	280	1300	10	90	72	A130URD72LI0280	A130URD72TTI0280
	315	1300	15	130	76	A130URD72LI0315	A130URD72TTI0315
	350	1300	21	180	77	A130URD72LI0350	A130URD72TTI0350
	400	1300	32	285	80	A130URD72LI0400	A130URD72TTI0400
	450	1300	44	380	87/89	A130URD72LI0450	A130URD72TTI0450
	500	1300	57	500	94/98	A130URD72LI0500	A130URD72TTI0500
	550	1300	68	590	110/120	A130URD72LI0550	A130URD72TTI0550
	630	1200	105	920	113	A120URD72LI0630	-
	630	1300	105	920	125	-	A130URD72TTI0630
	700	1100	145	1040	122	A110URD72LI0700	-
	700	1200	145	1040	140	-	A120URD72TTI0700
	800	1100	215	1590	125	A110URD72LI0800	-
800	1200	215	1590	146	-	A120URD72TTI0800	
73	315	1300	12	102	84	A130URD73LI0315	A130URD73TTI0315
	350	1300	17	150	86	A130URD73LI0350	A130URD73TTI0350
	400	1300	25	220	93	A130URD73LI0400	A130URD73TTI0400
	450	1300	35	310	99/100	A130URD73LI0450	A130URD73TTI0450
	500	1300	44	390	110/112	A130URD73LI0500	A130URD73TTI0500
	550	1300	57	500	116/120	A130URD73LI0550	A130URD73TTI0550
	630	1300	84	730	125/132	A130URD73LI0630	A130URD73TTI0630
	700	1300	110	960	135/146	A130URD73LI0700	A130URD73TTI0700
	800	1200	190	1630	136	A120URD73LI0800	-
	800	1300	190	1630	148	-	A130URD73TTI0800
	900	1100	250	2160	150	A110URD73LI0900	-
	900	1300	250	2160	170	-	A130URD73TTI0900
	1000	1100	370	2430	152/174	A100URD73LI1000	A110URD73TTI1000
	1100	1000	445	2580	168/208	A100URD73LI1100	A100URD73TTI1100
	1250	1000	585	3480	186/200	A100URD73LI1250	A100URD73TTI1250
1400	900	755	3880	210/228	A090URD73LI1400	A090URD73TTI1400	
1600	700	1430	5630	203	A070URD73LI1600	A070URD73TTI1600	
1800	650	2040	7600	206	A065URD73LI1800	A065URD73TTI1800	

** Watts loss data is published for both blade and tapped style mounting configurations. When two watts loss values are shown this represents tapped/blade values respectively.



1250/1300 Volt

SEMICONDUCTOR PROTECTION FUSES

A130 URD 70 & 12,5 URD 70 63 to 350A

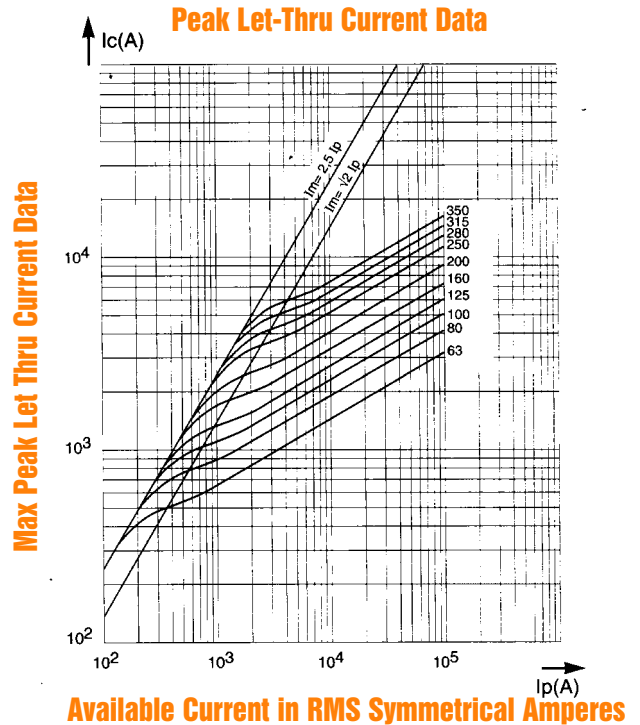
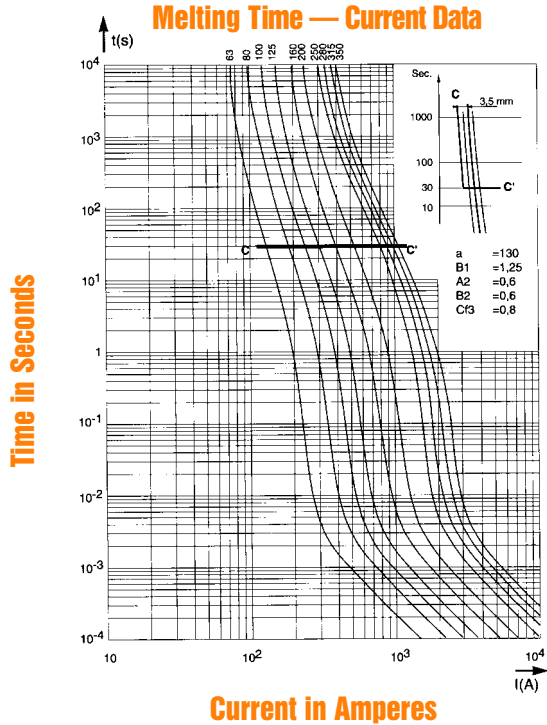

A130 URD 71 & 12,5 URD 71 160 to 630A

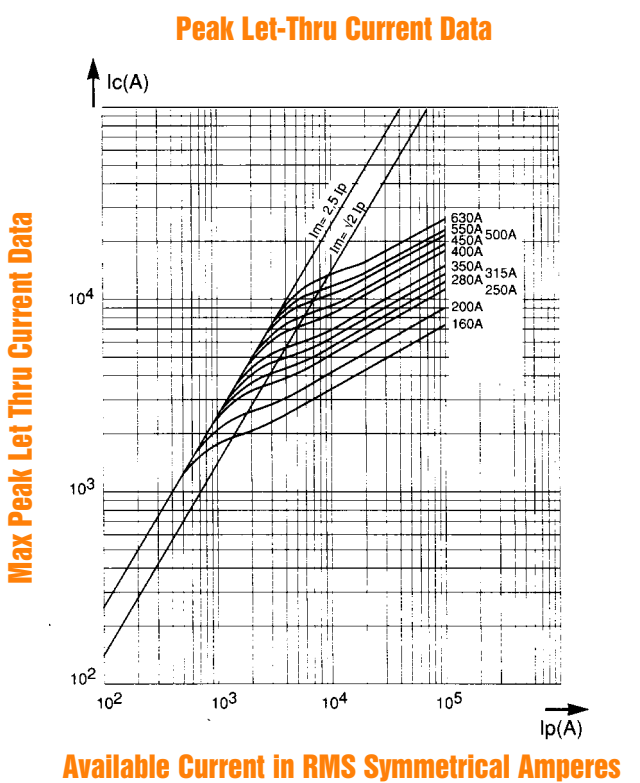
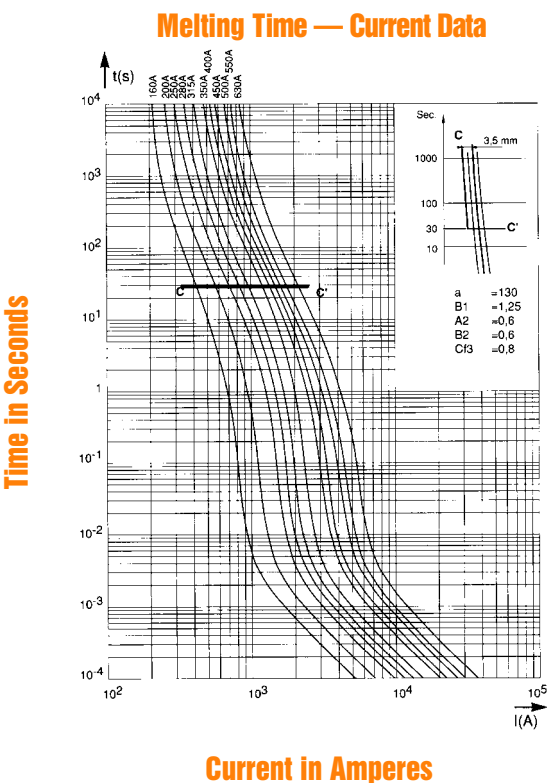

A130 URD 72 & 12,5 URD 72 280 to 800A

Melting Time — Current Data

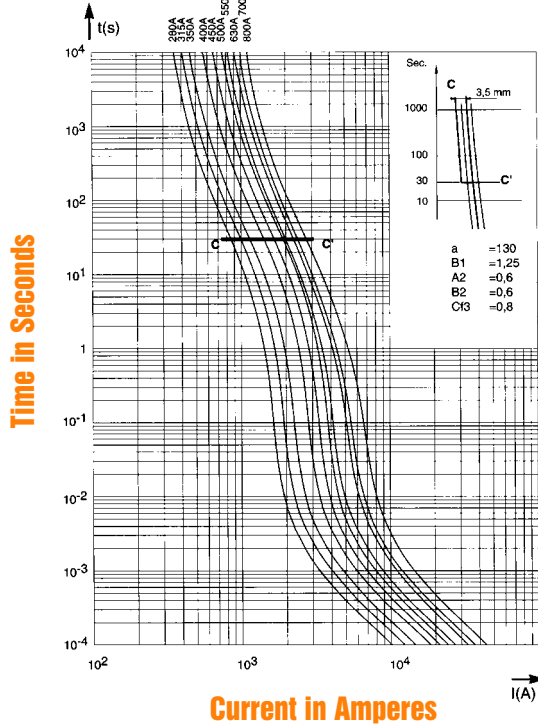

Peak Let-Thru Current Data

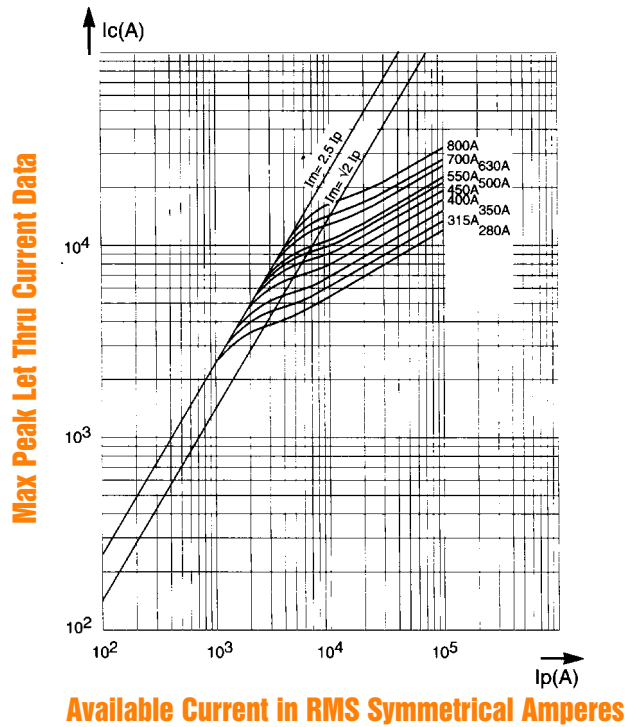

A130 URD 73 & 12,5 URD 73 315 to 1400A

Melting Time — Current Data

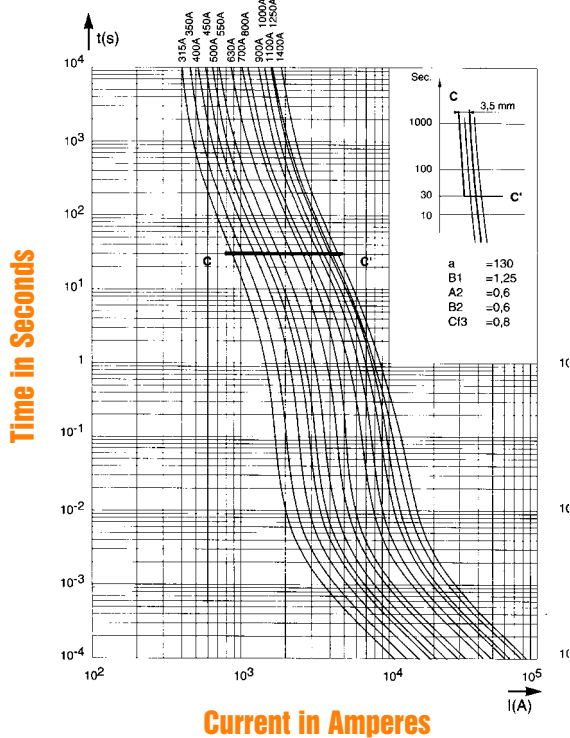

Peak Let-Thru Current Data

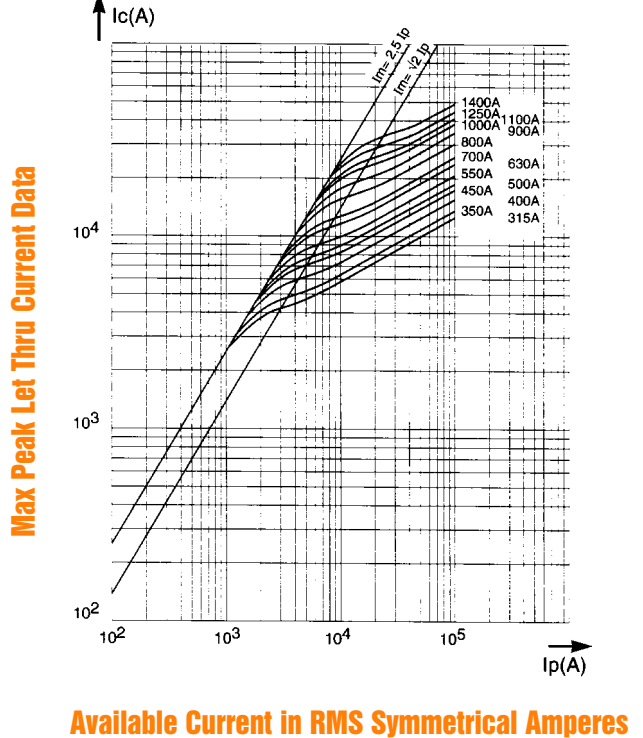

Clearing I²t vs. Operating Voltage

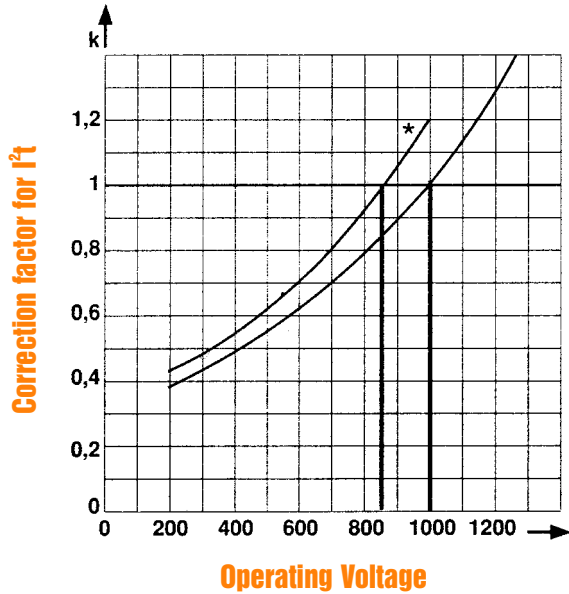

Watts Loss vs. Rated Current

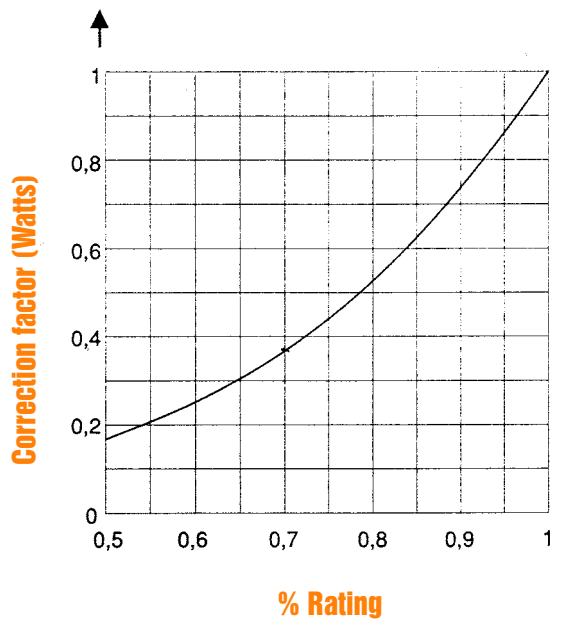

Correction factor to determine watts loss value of a fuse operating below its rated current.

Maximum Arc Voltage vs. System Voltage

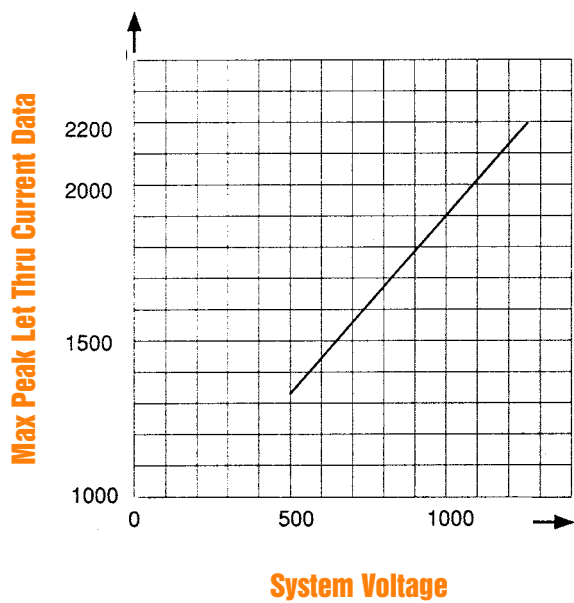

Determines the peak arc voltage across the fuse terminals as a function of applied voltage.

DC Voltage Capability vs. Time Constant

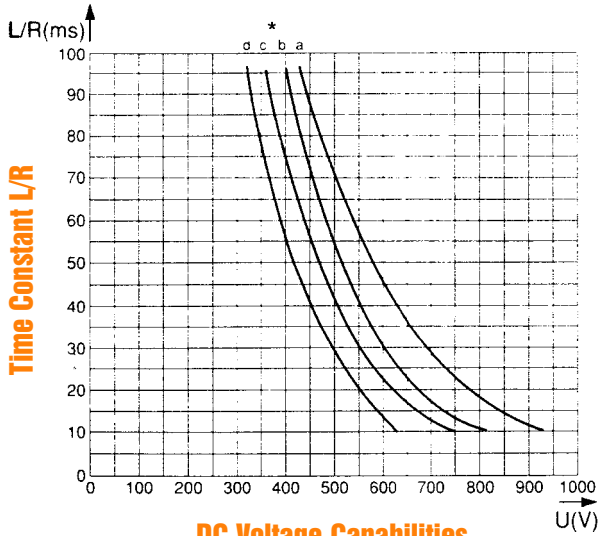

DC Voltage Capabilities

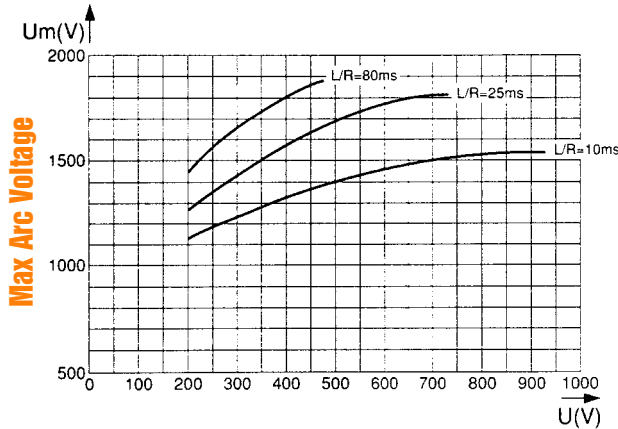

DC Working Voltage

Top: Provides the DC voltage capability of a fuse as a function of circuit time constant (L/R Ratio).

Below: Curves indicating peak arc voltage U_m which may appear across fuse terminals as a function of the DC working voltage U , for various time constant L/R of fault path.

RATED CURRENT I_N (A)	CURVES (*) AND IPM (†) CORRESPONDING TO THE RATING								
	70 *Ipm (A)	71 *Ipm (A)	72 *Ipm (A)	73 *Ipm (A)	2x72 *Ipm (A)	2x73 *Ipm (A)			
63	a	270							
80	a	400							
100	a	520							
125	a	700							
160	a	950	a	950					
200	a	1300	a	1300					
250	a	1800	a	1800					
280	b	2200	a	2000					
315	b	2600	a	2300	a	2000			
350	b	3000	a	2700	a	2400			
400			b	3500	a	3000			
450			b	4000	b	3800			
500			c	4800	b	4600			
550			c	5200	b	5000			
630			c	6400	b	6200			
700				c	6800	a	6000		
800					c	8000	a	6400	
900					b	9000	a	7600	
1000					c	11000	a	9200	
1100					c	12000	b	10000	
1250					c	13500	b	12400	
1400					c	16000	c	13600	
1600							c	16000	
1800								b	18000
2000								c	22000
2200								c	24000
2500								d	27000
2800								d	30000

Above: Ipm (1) values indicate the minimum breaking current in amperes (A).



1250/1300Volt 2x72, 2x73 SEMICONDUCTOR PROTECTION FUSES

SIZE	CATALOG NO.			REF #	WEIGHT (g)	
73	12,5	URD	73 PPAF 0315	H300640	1250	
	12,5	URD	73 PPAF 0350	J3002641		
	12,5	URD	73 PPAF 0400	K300642		
	12,5	URD	73 PPAF 0450	L300643		
	12,5	URD	73 PPAF 0500	M300644		
	12,5	URD	73 PPAF 0550	N300645		
	12,5	URD	73 PPAF 0630	P300646		
	12,5	URD	73 PPAF 0700	Q300674		
	12,5	URD	73 PPAF 0800	R300648		
	12	URD	73 PPAF 0900	S300649		
	10	URD	73 PPAF 1000	T300650		
	9,5	URD	73 PPAF 1100	V300651		
	9	URD	73 PPAF 1250	T300719		
8,5	URD	73 PPAF 1400	V300720			
2 X 72	12,5	URD	272 TTF 0630	W300721	1750	
	12,5	URD	272 TTF 0700	X300722		
	12,5	URD	272 TTF 0800	Y300723		
	12,5	URD	272 TTF 0900	Z300724		
	12,5	URD	272 TTF 1000	A300725		
	12,5	URD	272 TTF 1100	B300726		
	11	URD	272 TTF 1250	-		
	11	URD	272 TTF 1400	D300728		
	10	URD	272 TTF 1600	-		
	9	URD	272 TTF 1800	E301994		1900
	7,5	URD	272 TTF 2000	F301975		
	6,5	URD	272 TTF 2200	G301996		
	6,5	URD	272 TTF 2500	H301997		
12,5	URD	273 TTF 800	F300730	2600		
12,5	URD	273 TTF 900	G300731			
12,5	URD	273 TTF 1000	H300732			
12,5	URD	273 TTF 1100	J300733			
12,5	URD	273 TTF 1250	K300734			
11	URD	273 TTF 1400	K302229			
11	URD	273 TTF 1600	-			
11	URD	273 TTF 1800	-			
10	URD	273 TTF 2000	P300738		2800	
9,5	URD	273 TTF 2200	Q300739			
9,5	URD	273 PLAF 2200	M301909		2700	
9	URD	273 PLAF 2500	R300740			
8,5	URD	273 PLAF 2800	S300741			
6	URD	273 PLAF 3000	K301999			
6	URD	273 PLAF 3200	M302001			
5,5	URD	273 PLAF 3600	N302002			

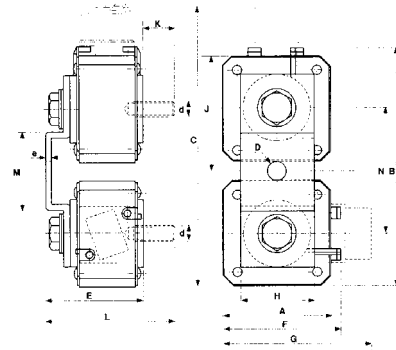

Microswitches and threaded studs supplied separately (see pages 420 and 422)

SIZE	A	B	C	D	E	F	G	H	J	K	d	e	L	M	N
2X72 TTF	60	138,5	172	11	91	65,5	100	35	66	39	M 10	4	131	48	72
2X73 TTF	74,5	167	200	13	91	79,6	114	50	80	39	M 12	4	131	54	86

Dimensions in mm

1250/1300 2X72 SEMICONDUCTOR PROTECTION FUSES

Melting Time Current Data

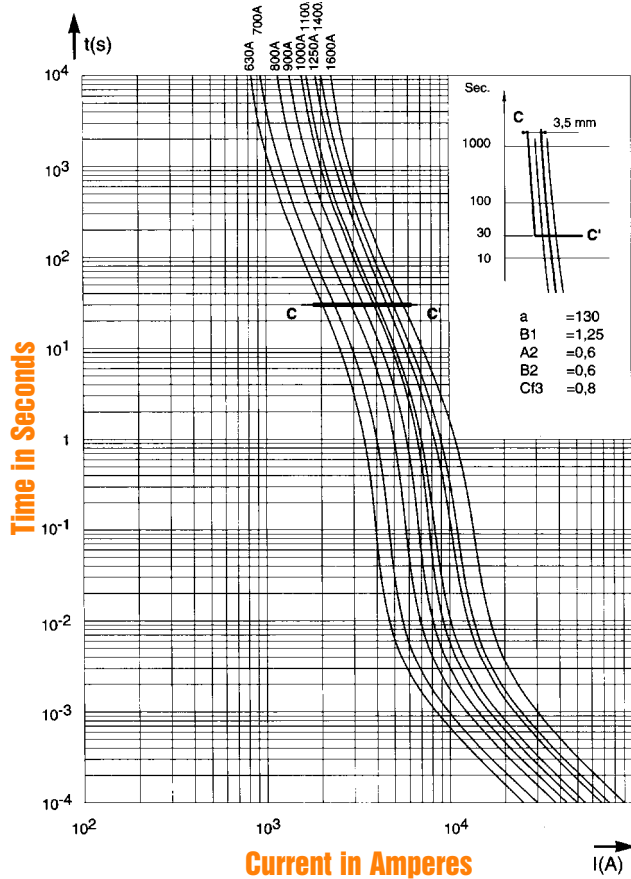

Peak let thru Current Data

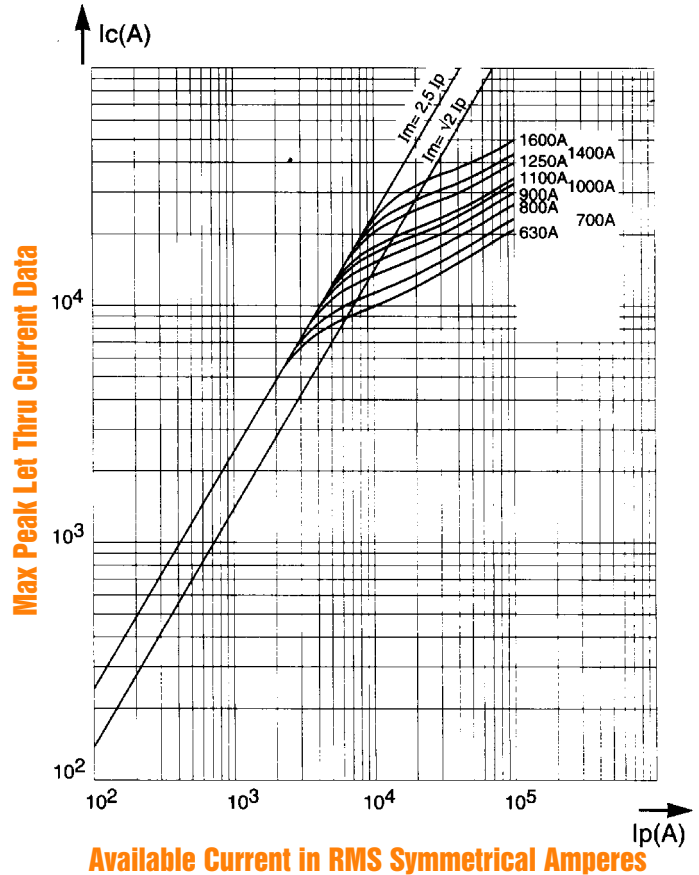

Time-current characteristics

- Above, left: Curves indicating pre-arcing time for each rated current as a function of RMS value of pre-arcing current I.
- Beyond 30 sec or 10 sec, small overloads must be eliminated by another device
- Curve CC' represents the maximum times taken by the associated device to clear small overloads; only its horizontal line is represented. Its oblique line must be plotted according to sketch, top right corner.
- The intersection of the fuse and CC' curves indicates the minimum breaking current I_{pm} of the fuse.

Maximum values of total clearing I²t and total operating times

Left: Horizontal curves indicating the maximum values of clearing I²t as function of the prospective current I_p at 660 V, cos w = 0.15.
The vertical lines indicate the corresponding clearing time T_t, with melting time in brackets.

PSC SQUARE BODY

1250/1300 2x73 SEMICONDUCTOR PROTECTION FUSES

Melting Time Current Data

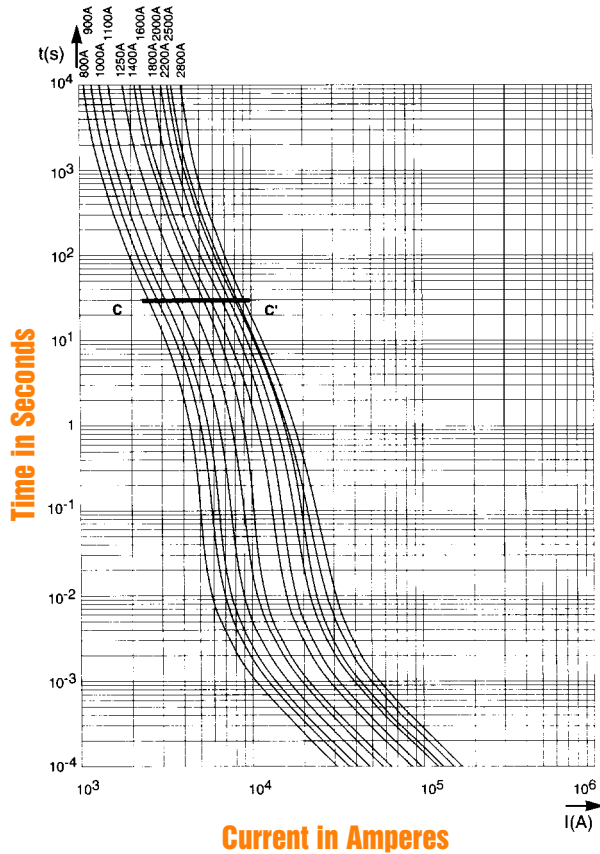

Peak let thru Current Data

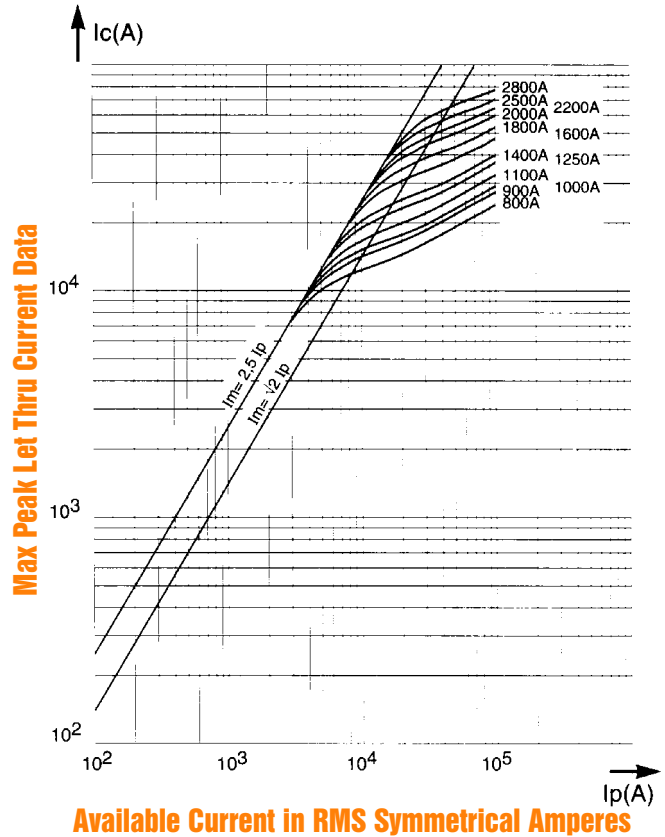

Clearing I²t Data

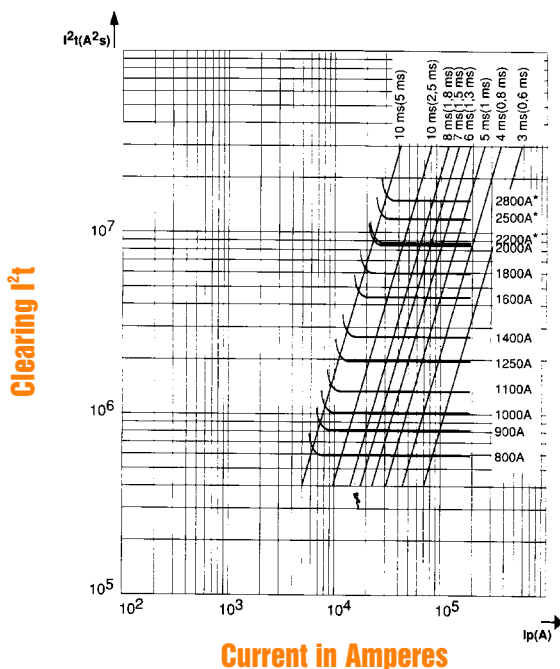

Time-current characteristics

Above, left: Curves indicating pre-arcing time for each rated current as a function of RMS value of pre-arcing current I.

- Beyond 30 sec small overloads must be eliminated by another device
- The intersection of the fuse and CC' curves indicates the minimum breaking current of the fuse.

Maximum values of total clearing I²t and clearing times

Left: Horizontal curves indicating the maximum values of total operating I²t as function of the prospective current I_p at 660 V, cos w = 0.15.

The vertical lines indicate the corresponding total operating time T_t, with melting time in brackets.