

NH DIMENSION

FUSE BASES

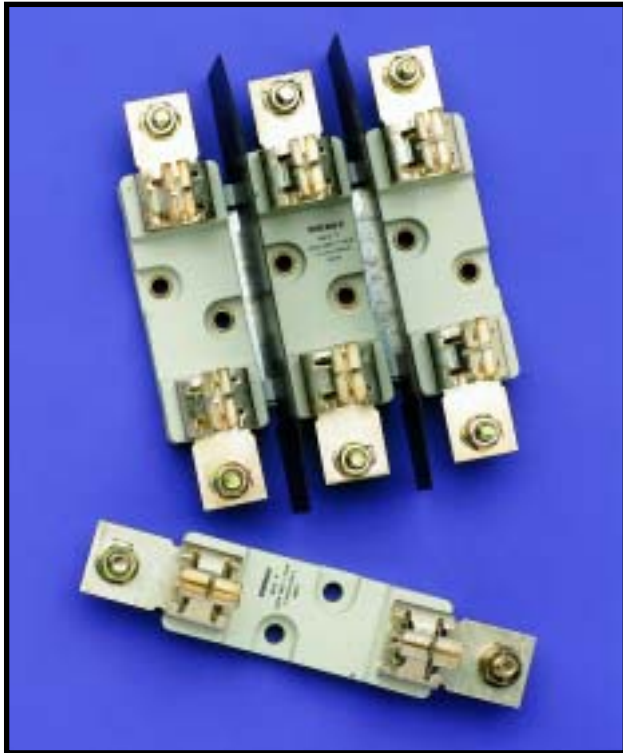

40510-G

Three-Pole Fuse Bases

SIZE	RATED CURRENT (A)	CATALOG NUMBER	STANDARD PACK
00-E	160	40502-G	3
00-EB	160	40503-G	3
0-E	160	40504-G	1
1-P	250	40508-G	1
2-P	400	40510-G	1
3-P	630	40512-G	1

Notes: Size 1 fuse base will accept size 0 fuses.
 Size 2 fuse base will accept size 1 fuses.
 Size 3 fuse base will accept size 1 & 2 fuses.
 Size 4 has a special nut to assure contact pressure.
 Types E and EP have square contacts
 Types P and PP have pincer contacts
 Type EB has pressure-plate cable connection.

690V CERAMIC FUSE BASES FOR NH FUSE-LINKS

- Ceramic insulating bases
- Silver plated contacts
- High spring contact pressure
- Screw mounting



40002-G

40006-G

Single-Pole Fuse Bases

SIZE	RATED CURRENT (A)	CATALOG NUMBER	STANDARD PACK
00-E	160	40002-G	12
00-EB	160	40003-G	12
0-E	160	40004-G	4
0-P	160	40006-G	4
1-P	250	40008-G	3
2-P	400	40010-G	3
3-P	630	40012-G	3
4-P	1250	40014-G	1



FRICITION FIT
45110-G



TAB FASTENED
45212-G

Insulating Barriers for Ceramic NH Fuse Bases

SIZE	RATED CURRENT (A)	CATALOG NUMBER	STANDARD PACK
00	100	45102-G	10
0	160	45104-G	10
1-2	400	45110-G	4
3	630	45112-G	2

00	100	45202-G	10
0	160	45204-G	10
1-2	400	45210-G	4
3	630	45212-G	2
4	1250	45214-G	2

NH DIMENSION

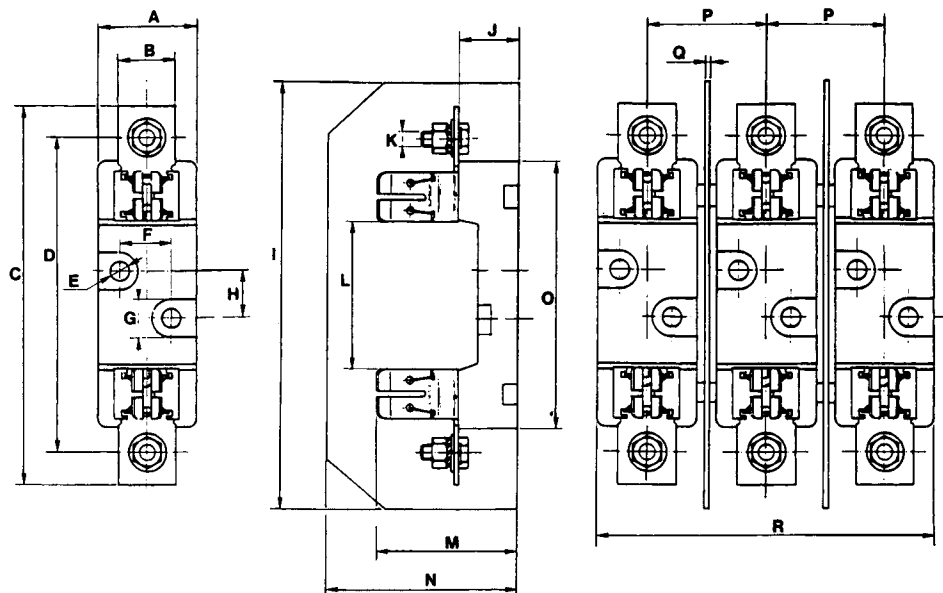

Dimensions of Ceramic Fuse Bases for NH Fuse-Links

	00-E, EB	0-E	0-P	1-P	2-P	3-P	4-P
A	33	32	32	55	55	55	80
B	20	20	25	32	35	40	45
C	118.5	269	166	210	227	241	312
D	100	151	150	175	200	210	262
E*	8	8.5	8.5	11	11	11	11
F	-	-	-	30	30	30	45
G	14.5	14	14	22	22	22	-
H	25	25	25	25	25	25	30
I	145	185	185	250	250	250	-
J	21.5	29	29	35	35	35	45
K	8	8	8	10	10	12	16
L	55	72	74	84	84	84	111
M	52.5	60	60	71	89	103	145
N	80	85	85	100	100	127	-
O	84	120	120	148	148	148	192
P	34	47	47	62	69	82	-
Q	1	2	2	2	2	2	-
R	101	126	126	177	190	213	-

* 8mm for all multiple pole bases; dimensions in chart for single pole bases.

NH DIMENSION

FUSE BASES

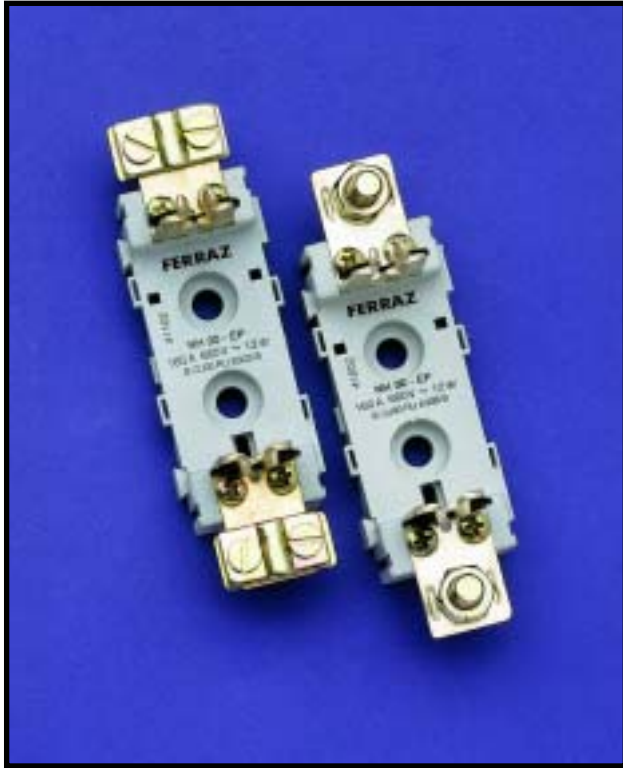

690V POLYESTER FUSE BASES FOR NH FUSE-LINKS

- Polyester insulating bases
- Silver plated contacts
- High pressure spring contacts
- Screw or rail mount

Connection Detail



Type 00-EP* — Fuse Bases for NH-00 Fuse-links

POLES	CATALOG NUMBER				STANDARD PACK
	SCREW CONNECTOR		PRESSURE PLATE CONNECTOR		
	SCREW MT.	RAIL MT.	SCREW MT.	RAIL MT.	
1	41002-G	42002-G	41102-G	42102-G	3
2	41012-G	42012-G	41112-G	42112-G	2
3	41014-G	42014-G	41114-G	42114-G	1
4	41019-G	42019-G	41119-G	42119-G	1

* EP bases have square contacts.

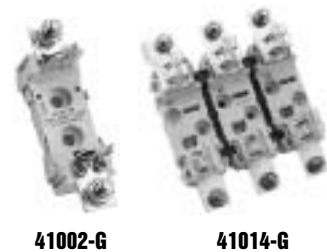

41002-G

41014-G



Dimensions

	00-EP
A	32
B	20
C	117
D	100
E	8
F	2
G	14
H	25
I	145
J	21.5
K	8
L	56
M	52
N	85
O	84
P	34
Q	1
R	104

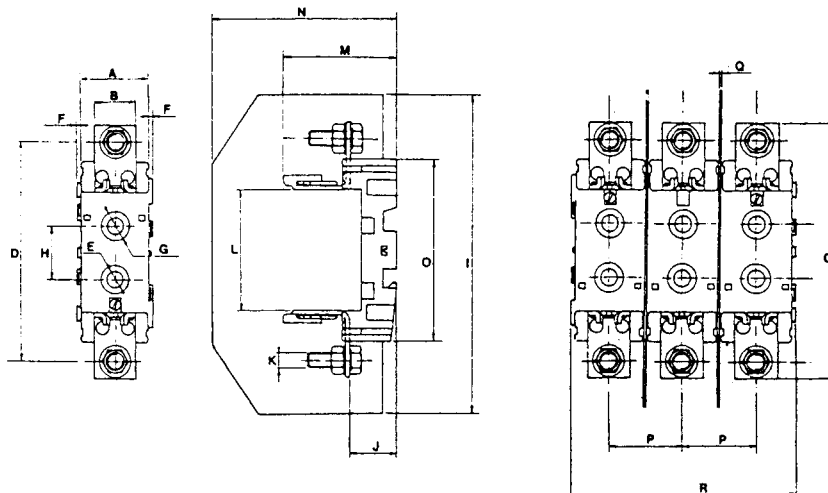

NH DIMENSION

FUSE BASES

Type 0-EP* — Fuse Bases for NH-0 Fuse-links

POLES	CATALOG NUMBER		STANDARD PACK
	MOUNTING STYLE		
	SCREW	DIN RAIL	
1	41202-G	42202-G	3
2	41212-G	42212-G	2
3	41214-G	42214-G	1
4	41219-G	42219-G	1

* EP bases have square contacts. PP bases have pincer contacts.



42202-G



41412-G



41514-G

Type 0-PP — Fuse Bases for NH-0 Fuse-links

1	41302-G	42302-G	3
2	41312-G	42312-G	2
3	41314-G	42314-G	1
4	41319-G	42319-G	1

Type 1-PP — Fuse Bases for NH-1 Fuse-links

1	41402-G	42402-G	3
2	41412-G	42412-G	2
3	41414-G	42414-G	1
4	41419-G	42419-G	1

Type 2-PP — Fuse Bases for NH-2 Fuse-links

1	41502-G	42502-G	3
2	41512-G	42512-G	2
3	41514-G	42514-G	1
4	41519-G	42519-G	1

Type 3-PP — Fuse Bases for NH-3 Fuse-links

1	41602-G	42602-G	3
2	41612-G	42612-G	2
3	41614-G	42614-G	1
4	41619-G	42619-G	1

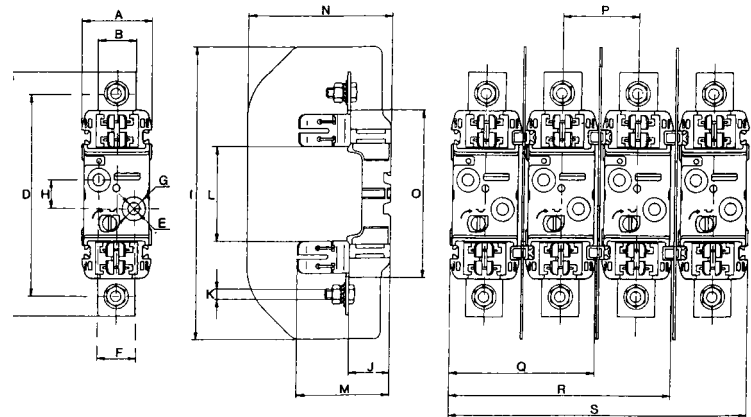

Dimensions of Polyester Fuse Bases for NH Fuse-Links

	0-EP	0-PP	1-PP	2-PP	3-PP
A	46	46	60	60	60
B	20	25	32	35	40
C	168	168	209	225	241
D	150.5	150.5	176	201	210
E	7.5	7.5	10.5	10.5	10.5
F	-	-	30	30	30
G	14.5	14.5	20.5	20.5	20.5
H	25	25	25	25	25
I	185	185	250	250	270
J	29	29	35	35	35
K	M8	M8	M10	M10	M12
L	74	75	81	81	81
M	59	61	71	89	103
N	95	95	122.5	122.5	142.5
O	122	122	146	146	146
P	48.5	48.5	65.5	65.5	81.5
Q	94	94	125.5	125.5	141.5
R	142	142	191	191	223
S	190	190	256.5	256.5	304.5

NH DIMENSION

FUSE BASES

Insulating Barriers for Polyester NH Fuse Bases

SIZE	RATED In CURRENT (A)	CATALOG NUMBER	STANDARD PACK
00	100	44502-G	2
0	160	44504-G	2
1-2	400	44510-G	2
3	630	44512-G	2

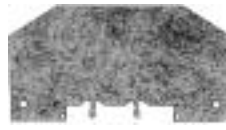

44502-G

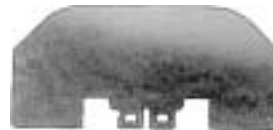

44510-G

Separators

SIZE	RATED In CURRENT (A)	CATALOG NUMBER	STANDARD PACK
0	160	44604-G	2
1-2	400	44610-G	2
3	630	44612-G	2



44610-G



44702-G

Fuse Shields

SIZE	RATED In CURRENT (A)	CATALOG NUMBER	STANDARD PACK
00	100	44802-G	3
0	160	44804-G	3
1-2	400	44810-G	3



44802-G

Terminal Shields

SIZE	RATED In CURRENT (A)	CATALOG NUMBER	STANDARD PACK
00	100	44702-G	6
0	160	44704-G	6
1-2	400	44710-G	6

One Cable — Terminal for NH Bases

BASE SIZE	CABLE SIZE (mm)		CATALOG NUMBER	STANDARD PACK
	MAX.	MIN.		
00	50	6	45421-G	60
00-0	95	10	45423-G	50
1	150	16	45425-G	30
2-3	240	50	45427-G	15



45425-G

Two Cable — Terminal for NH Bases

BASE SIZE	CABLE 1 (Size mm)		CABLE 2 (Size mm)		CATALOG NUMBER	STANDARD PACK
	MAX.	MIN.	MAX.	MIN.		
00	50	6	50	6	45431-G	60
00-0	95	10	95	10	45433-G	30
1	150	25	150	16	45435-G	20
2-3	240	95	240	50	45437-G	5



45435-G

Dimensions of Terminals

CATALOG NUMBER	A	B	C	M
45421-G	18	26	34	6
45423-G	24	35	52	8
45425-G	26	41	58	10
45427-G	36	53	68	12
45431-G	18	26	39	6
45433-G	24	35	82	8
45435-G	26	41	84	10
45437-G	36	53	98	12

