

LBS

LOAD BREAK DISCONNECT SWITCHES



Ferraz Shawmut LBS load break disconnect switches have been designed for today's industrial control systems. The LBS switches allow you to safely turn power to your panel on and off or to isolate a particular circuit within the panel. These switches are extremely compact and offer a variety of mounting options like DIN rail mounting, base mounting, or door mounting. A wide assortment of handles, shafts and accessories are available to provide you with the ultimate flexibility in the design of your industrial control panels. Wiring terminations are integral to the switch body and recessed to insure a "finger safe" environment according to IEC standards to an IP20 grade of protection.

HIGHLIGHTS:

- Finger Safe
- Compact footprint
- DIN rail or base mount standard
- Door mounting optional
- Choice of external handles/shafts
- Direct mount handle option
- Toggle handle option

APPLICATIONS:

- On/Off switching and disconnect applications in circuits up to 600 volts, 125 amperes on the load side of branch circuit protection fusing.
- LBS M range: Motor Controller
LBS R range: Motor Controller suitable as Motor Disconnect
- Motor Isolator
- General Purpose

Ratings

- 600 VAC
- 16, 20, 25, 30, 40, 60, 80, 100, and 125 amperes

Approvals

- Meets the requirements of UL 508
- UL Listed Guide NLRV File E196672
- cUL Listed Guide NLRV7 File E196672
- CSA certified
- IEC 947-3 as load break disconnect



LBS M

LOAD BREAK DISCONNECT SWITCHES

LBS RANGE: Load Break Disconnect Switches from 16 to 125 Amperes



SELECT A SWITCH

AMPERE RATING
CATALOG NUMBER: 3 POLE

16	20	25	30
LBSM16	LBSM20	LBSM25	LBSM30



SELECT A HANDLE

NEMA TYPE	IEC TYPE	DEFEATABLE	COLOR	CATALOG NUMBER			
1, 3R, 12, 4, 4X	IP65	NO	Black	HMSB	HMSB	HMSB	HMSB
1, 3R, 12, 4, 4X	IP65	NO	Red/Yellow	HMSR	HMSR	HMSR	HMSR



SELECT A SHAFT

SHAFT LENGTH (inches/mm)	CATALOG NUMBER*			
2.75 / 70	SM70-5L	SM70-5L	SM70-5L	SM70-5L
4.72 / 120	SM120-5L	SM120-5L	SM120-5L	SM120-5L
7.9 / 200	SM200-5L	SM200-5L	SM200-5L	SM200-5L
12.0 / 305	SM300-5L	SM300-5L	SM300-5L	SM300-5L



SELECT A HANDLE

NEMA TYPE	IEC TYPE	DEFEATABLE	COLOR	CATALOG NUMBER			
1, 3R, 12	IP54	YES	Black	HDPB	HDPB	HDPB	HDPB
1, 3R, 12	IP54	YES	Red/Yellow	HDPR	HDPR	HDPR	HDPR
1, 3R, 12	IP54	NO	Black	HDPBND	HDPBND	HDPBND	HDPBND
1, 3R, 12	IP54	NO	Red/Yellow	HDPRND	HDPRND	HDPRND	HDPRND



SELECT A SHAFT

SHAFT LENGTH (inches/mm)	CATALOG NUMBER*			
4.72/120	SD120-5L	SD120-5L	SD120-5L	SD120-5L
7.9/200	SD200-5L	SD200-5L	SD200-5L	SD200-5L
12.6/320	SD320-5L	SD320-5L	SD320-5L	SD320-5L
15.75/400	SD400-5L	SD400-5L	SD400-5L	SD400-5L

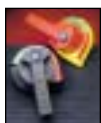

SELECT A HANDLE

NEMA TYPE	IEC TYPE	DEFEATABLE	COLOR	CATALOG NUMBER			
1, 3R, 12	IP54	YES	Black	HGPB	HGPB	HGPB	HGPB
1, 3R, 12	IP54	YES	Red/Yellow	HGPR	HGPR	HGPR	HGPR
1, 3R, 12, 4, 4X	IP65	YES	Black	HGPB4	HGPB4	HGPB4	HGPB4
1, 3R, 12, 4, 4X	IP65	YES	Red/Yellow	HGPR4	HGPR4	HGPR4	HGPR4



SELECT A SHAFT

SHAFT LENGTH (inches/mm)	CATALOG NUMBER*			
4.72/120	SG120-5L	SG120-5L	SG120-5L	SG120-5L
7.9/200	SG200-5L	SG200-5L	SG200-5L	SG200-5L
12.6/320	SG320-5L	SG320-5L	SG320-5L	SG320-5L
15.75/400	SG400-5L	SG400-5L	SG400-5L	SG400-5L

OPTIONS

Modular 4th power pole (rating same as switch)
 Neutral pole (feed through, not switched, rated 30A, 480VAC)
 Ground pole (feed through, not switched, rated 30A, 480VAC)
 (1) NO+NC, side mount, pre-break auxiliary contact, A300, rated 15A @ 120 VAC
 Terminal shroud (for 3 pole switch)
 Terminal shroud for modular 4th pole or NMM or GMM
 Direct mounted handle (requires removing collar from switch)

CATALOG NUMBER

PPM16	PPM20	PPM25	PPM30
NMM	NMM	NMM	NMM
GMM	GMM	GMM	GMM
ACMM	ACMM	ACMM	ACMM
TSLSM	TSLSM	TSLSM	TSLSM
TSLSM4	TSLSM4	TSLSM4	TSLSM4
HAD60M	HAD60M	HAD60M	HAD60M

OTHER VERSIONS AVAILABLE: Switch with Direct Mounted Handles

AMPERE RATING
CATALOG NUMBER: 3 POLE

16	20	25	30
LBSM16DH	LBSM20DH	LBSM25DH	LBSM30DH

Please consult factory for availability of switches with direct mounted handles-special order parts. Options same as above.



Door mounted switches

AMPERE RATING
CATALOG NUMBER: 3 POLE

16	20	25	30
LBSDM16	LBSDM20	LBSDM25	LBSDM30



SELECT A HANDLE

NEMA TYPE	IEC TYPE	DEFEATABLE	COLOR	CATALOG NUMBER			
1, 3R, 12, 4, 4X	IP65	NO	Black	HMSB	HMSB	HMSB	HMSB
1, 3R, 12, 4, 4X	IP65	NO	Red/Yellow	HMSR	HMSR	HMSR	HMSR

OPTIONS

Modular 4th power pole (rating same as switch)
 Neutral pole (feed through, not switched, rated 30A, 480VAC)
 Ground pole (feed through, not switched, rated 30A, 480VAC)
 (1) NO+NC, side mount, pre-break auxiliary contact, A300, rated 15A @ 120 VAC

CATALOG NUMBER

PPDM16	PPDM20	PPDM25	PPDM30
NDMM	NDMM	NDMM	NDMM
GDMM	GDMM	GDMM	GDMM
ACDMM	ACDMM	ACDMM	ACDMM

*Note: All "-5L" shafts have door interlock pinned at factory (no assembly required)



LBS R & T

LOAD BREAK DISCONNECT SWITCHES



SELECT A SWITCH

AMPERE RATING
CATALOG NUMBER: 3 POLE
CATALOG NUMBER: 4 POLE

30	40	60	80	100	125
LBSR30	LBSR40	LBSR60	LBSR80	LBSR100	LBSR125
LBSR304	LBSR404	—	—	—	—



SELECT A HANDLE

NEMA TYPE	IEC TYPE	DEFEATABLE	COLOR	CATALOG NUMBER					
1, 3R, 12, 4, 4X	IP65	NO	Black	HMSB	HMSB	HMSB	HMSB	HMSB	HMSB
1, 3R, 12, 4, 4X	IP65	NO	Red/Yellow	HMSR	HMSR	HMSR	HMSR	HMSR	HMSR



SELECT A SHAFT

SHAFT LENGTH (inches/mm)	CATALOG NUMBER*					
2.75 / 70	SM70-5L	SM70-5L	SM70-5L	SM70-5L	SM70-5L	SM70-5L
4.72 / 120	SM120-5L	SM120-5L	SM120-5L	SM120-5L	SM120-5L	SM120-5L
7.9 / 200	SM200-5L	SM200-5L	SM200-5L	SM200-5L	SM200-5L	SM200-5L
12.0 / 305	SM300-5L	SM300-5L	SM300-5L	SM300-5L	SM300-5L	SM300-5L
	OR	OR	OR	OR	OR	OR



SELECT A HANDLE

NEMA TYPE	IEC TYPE	DEFEATABLE	COLOR	CATALOG NUMBER					
1, 3R, 12	IP54	YES	Black	HDPB	HDPB	HDPB	HDPB	HDPB	HDPB
1, 3R, 12	IP54	YES	Red/Yellow	HDPR	HDPR	HDPR	HDPR	HDPR	HDPR
1, 3R, 12	IP54	NO	Black	HDPBND	HDPBND	HDPBND	HDPBND	HDPBND	HDPBND
1, 3R, 12	IP54	NO	Red/Yellow	HDPRND	HDPRND	HDPRND	HDPRND	HDPRND	HDPRND



SELECT A SHAFT

SHAFT LENGTH (inches/mm)	CATALOG NUMBER*					
4.72/120	SD120-5L	SD120-5L	SD120-5L	SD120-5L	SD120-5L	SD120-5L
7.9/200	SD200-5L	SD200-5L	SD200-5L	SD200-5L	SD200-5L	SD200-5L
12.6/320	SD320-5L	SD320-5L	SD320-5L	SD320-5L	SD320-5L	SD320-5L
15.75/400	SD400-5L	SD400-5L	SD400-5L	SD400-5L	SD400-5L	SD400-5L
	OR	OR	OR	OR	OR	OR

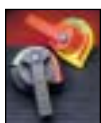

SELECT A HANDLE

NEMA TYPE	IEC TYPE	DEFEATABLE	COLOR	CATALOG NUMBER					
1, 3R, 12	IP54	YES	Black	HGPB	HGPB	HGPB	HGPB	HGPB	HGPB
1, 3R, 12	IP54	YES	Red/Yellow	HGPR	HGPR	HGPR	HGPR	HGPR	HGPR
1, 3R, 12, 4, 4X	IP65	YES	Black	HGPB4	HGPB4	HGPB4	HGPB4	HGPB4	HGPB4
1, 3R, 12, 4, 4X	IP65	YES	Red/Yellow	HGPR4	HGPR4	HGPR4	HGPR4	HGPR4	HGPR4



SELECT A SHAFT

SHAFT LENGTH (inches/mm)	CATALOG NUMBER*					
4.72/120	SG120-5L	SG120-5L	SG120-5L	SG120-5L	SG120-5L	SG120-5L
7.9/200	SG200-5L	SG200-5L	SG200-5L	SG200-5L	SG200-5L	SG200-5L
12.6/320	SG320-5L	SG320-5L	SG320-5L	SG320-5L	SG320-5L	SG320-5L
15.75/400	SG400-5L	SG400-5L	SG400-5L	SG400-5L	SG400-5L	SG400-5L

OPTIONS

(1) NO Auxiliary contact rated 10A, 600VAC, A600-Q600
 (1) NC Auxiliary contact rated 10A, 600VAC, A600-Q600
 Auxiliary contact holder: 3 pole (accommodates up to 6 auxiliary contacts)
 4 pole (accommodates up to 6 auxiliary contacts)
 Door mounting kit for LBSR switches
 Direct mounted handle (requires removing collar from switch)

CATALOG NUMBER					
AC11	AC11	AC11	AC11	AC11	AC11
AC12	AC12	AC12	AC12	AC12	AC12
ACHLBS1	ACHLBS1	ACHLBS2	ACHLBS2	ACHLBS2	ACHLBS2
ACHLBS14	ACHLBS14	—	—	—	—
DMKLBSR	DMKLBSR	DMKLBSR	DMKLBSR	DMKLBSR	DMKLBSR
HAD40R	HAD40R	HAD80R	HAD80R	HAD80R	HAD80R

OTHER VERSIONS AVAILABLE:



Switch with Direct Mounted Handles (includes escutcheon plate for lockout capabilities)

AMPERE RATING
CATALOG NUMBER: 3 POLE
CATALOG NUMBER: 4 POLE

30	40	60	80	100	125
LBSR30DH	LBSR40DH	LBSR60DH	LBSR80DH	LBSR100DH	LBSR125DH
LBSR304DH	LBSR404DH	—	—	—	—

Please consult factory for availability of switches with direct mounted handles-special order parts. Options same as above.



Toggle style

AMPERE RATING
CATALOG NUMBER: 3 POLE
CATALOG NUMBER: 4 POLE

30	40	60	80	100	125
LBST30	LBST40	LBST60	LBST80	LBST100	LBST125
LBST304	LBST404	—	—	—	—

Optional DIN escutcheon plate for lockout capabilities.

CATALOG NUMBER: 3 POLE
CATALOG NUMBER: 4 POLE

CP40T	CP40T	CP80T	CP80T	CP80T	CP80T
CP40T4P	CP40T4P	—	—	—	—

(No lockout capability for 4 pole)

*Note: All "-5L" shafts have door interlock pinned at factory (no assembly required)

LBS M

LOAD BREAK DISCONNECT SWITCHES FROM 16 TO 30 A

UL AND cUL TECHNICAL CHARACTERISTICS FOR LBS M RANGE MOTOR CONTROLLER ONLY

Rating		LBS M			
		16 A	20 A	25 A	30 A
Approval		UL508/cUL	UL508/cUL	UL508/cUL	UL508/cUL
Short-circuit rating kA at 600 V AC		5	5	5	5
Branch circuit fuse type		RK5	RK5	RK5	RK5
Max fuse rating (A)		30	30	30	30
Maximum UL Horsepower ratings (3-ph)	208V AC	3	5	7.5	7.5
	220-240V AC	5	5	7.5	7.5
	440-480V AC	10	10	15	15
	600V AC	10	15	20	20
Maximum UL Horsepower ratings (1-ph)	120 V AC	1	1.5	2	2
	240 V AC	2	3	3	5
DC ratings (A)		16	20	25	30
2 pole in series					
Terminal lugs	wire type	Cu	Cu	Cu	Cu
	wire size (solid)	#10-#14	#10-#14	#10-#14	#10-#14
	wire size (stranded)	#6-#14	#6-#14	#6-#14	#6-#14
Weight (lb)		0.32	0.32	0.32	0.32

IEC 947-3 TECHNICAL CHARACTERISTICS

THERMAL CURRENT I _{th} (40 °C)		LBS M			
		16 A	20 A	25 A	32 A
Rated insulation voltage U _i (V)		800	800	800	800
Rated impulse withstand U _{imp} (kV)		8	8	8	8
OPERATIONAL CURRENT (A)					
400 V AC	AC 22 A	16	20	25	32
	AC 23 A	16	20	25	32
500 V AC	AC 22 A	16	20	25	32
	AC 23 A	16	16	20	25
690 V AC	AC 22 A	16	20	25	32
	AC 23 A	16	16	20	20
MOTOR POWER (KW)					
400 V AC	AC 23	7	9	11	15
500 V AC	AC 23	9	9	11	15
690 V AC	AC 23	11	11	15	15
OVERLOAD CAPACITY					
Short-circuit current with gG fuses (kA Rms)		50	50	50	50
Maximum rating for associated gG fuses (A)		16	20	25	32
Cut-off current (kA peak)		5.9	5.9	5.9	5.9
Short-time withstand current I _{cw} 1s (kA)		1.2	1.2	1.2	1.2
MECHANICAL ENDURANCE (# of operations)		100 000	100 000	100 000	100 000
CONNECTION					
Cu (mm ²)	3p/4p	1.5 to 16	1.5 to 16	1.5 to 16	1.5 to 16

Note: 4-pole made by using modular 4th pole (see options, page 3, ie PPM16 or PPDM16)



LBS R & T LOAD BREAK DISCONNECT SWITCHES FROM 30 TO 125 A

UL AND CSA TECHNICAL CHARACTERISTICS FOR LBS R & LBS T RANGE MOTOR CONTROLLER SUITABLE AS MOTOR DISCONNECT

Rating		LBS R & LBS T					
		30 A	40 A	60 A	80 A	100 A	125 A
Approvals		UL508/CSA ⁽¹⁾	UL508/CSA ⁽¹⁾	UL508/CSA ⁽¹⁾	UL508/CSA ⁽¹⁾	UL508	UL508 ⁽²⁾
Short-circuit rating kA at 600 V AC		10	10	10	10	10	10
Branch circuit fuse type		RK5	RK5	H, K or RK5	H, K or RK5	H, K or RK5	H, K or RK5
Max fuse rating (A)		80	80	150	150	150	150
Maximum UL Horsepower ratings (3-ph)	208V AC	7.5	7.5	10	15	20	20
	220-240V AC	7.5	7.5	15	20	20	25
	440-480V AC	15	20	30	40	40	50
	600V AC	20	25	40	50	-	60
Maximum UL Horsepower ratings (1-ph)	120 V AC	1.5	2	2	3	5	5
	240 V AC	3	3	7.5	10	15	15
DC ratings (A)	125 V DC	30	40	60	80	80	80
2 pole in series							
Terminal lugs	wire type	Cu	Cu	Cu	Cu	Cu	Cu
	wire size (solid)	#10-#14	#10-#14	#10-#14	#10-#14	#10-#14	#10-#14
	wire size (stranded)	#4-#14	#4-#14	#1-#14	#1-#14	#1-#14	#1-#14
Weight (lb)		0.44	0.44	0.66	0.66	0.66	0.66

(1) CSA certified: 3 pole version only

(2) UL508 motor controller only

IEC 947-3 TECHNICAL CHARACTERISTICS

THERMAL CURRENT I _{th} (40 °C)		LBS R & LBS T					
		32 A	40 A	63 A	80 A	100 A	125 A
Rated insulation voltage U _i (V)		690	690	690	690	690	690
Rated impulse withstand U _{imp} (kV)		8	8	8	8	8	8
OPERATIONAL CURRENT (A)							
400 V AC	AC 22 A	32	40	63	80	100	-
	AC 23 A	25	25	63	63	63	-
500 V AC	AC 22 A	32	40	63	80	100	-
	AC 23 A	25	25	45	45	45	-
690 V AC	AC 22 A	32	40	63	80	80	-
	AC 23 A	25	25	40	40	40	-
MOTOR POWER (KW)							
400 V AC	AC 23	11	11	30	30	30	-
500 V AC	AC 23	15	15	30	30	30	-
690 V AC	AC 23	22	22	33	33	33	-
OVERLOAD CAPACITY							
Short-circuit current with gG fuses (kA Rms)		50	50	50	50	50	-
Maximum rating for associated gG fuses (A)		32	40	63	80	100	-
Cut-off current (kA peak)		4.5	5	5	-	-	-
Short-time withstand current I _{cw} 1s (kA)		0.9	1	1.5	1.5	1.5	-
MECHANICAL ENDURANCE (# of operations)		20 000	20 000	20 000	20 000	20 000	-
CONNECTION							
Cu (mm ²)	3p	1.5 to 16	1.5 to 16	1.5 to 35	1.5 to 35	1.5 to 35	-
	4p	1.5 to 25	1.5 to 25	-	-	-	-

LBS

LOAD BREAK DISCONNECT SWITCHES

DIMENSIONS (dual dimensions: in/mm)

LBS M - BASE MOUNTING

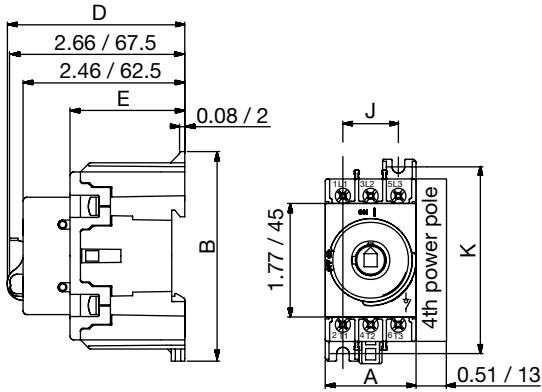

LBS R - BASE MOUNTING

30 - 40 A
3 poles

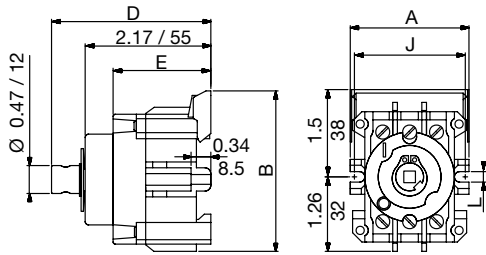

60 - 80 - 100 - 125 A
3 poles

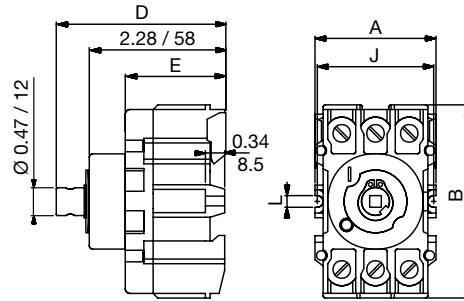

30 - 40 A
4 poles

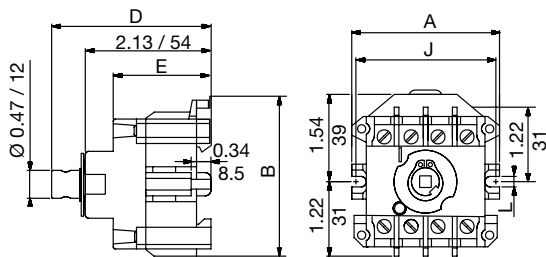

RATING	NUMBER OF POLES	A		B		D		E		J		K		L	
		In	mm	In	mm	In	mm	In	mm	In	mm	In	mm	In	mm
LBS M 16 A LBS M 20 A LBS M 25 A LBS M 30 A	3 P	1.42	36	3.15	80	2.76	70	1.76	44.5	0.87	22	2.92	74	-	-
LBS R 30 A LBS R 40 A	3 P	2.01	51	2.76	70	2.71	69	1.66	42	1.89	48	-	-	0.17	4.2
	4 P	2.42	61.5	2.76	70	2.71	69	1.66	42	2.38	60.5	-	-	0.17	4.2
LBS R 60 A LBS R 80 A LBS R 100 A LBS R 125 A	3 P	2.09	53	3.35	85	2.87	73	1.69	43	2.05	52	-	-	0.17	4.2

LBS

LOAD BREAK DISCONNECT SWITCHES

DIMENSIONS (dual dimensions: in/mm)

LBS R DIMENSIONS WITH AUXILIARY CONTACTS

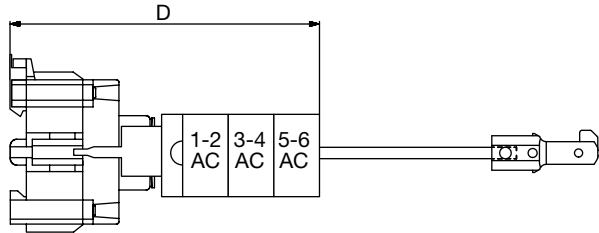

LBS R	D (in/mm)		
	1-2 AC	3-4 AC	5-6 AC
30-40A 3 poles	3.63 / 92	4.53 / 115	5.44 / 138
30-40A 4 poles	3.63 / 92	4.53 / 115	5.44 / 138
60-80 100-125A 3 poles	3.78 / 96	4.69 / 119	5.60 / 142

Note: Auxiliary contacts can be used with external operation only.

LBS T (TOGGLE STYLE) - BASE MOUNTING

30 - 40 A 3 poles

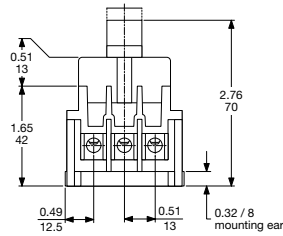
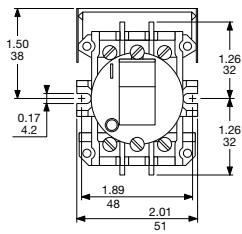

30 - 40 A 4 poles

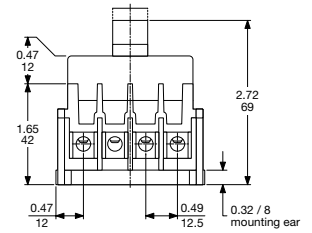
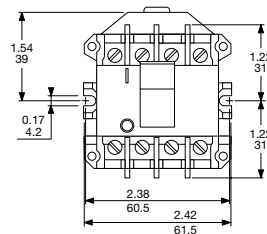

60 - 80 - 100 - 125 A 3 poles

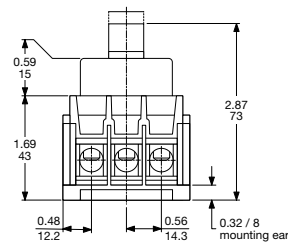
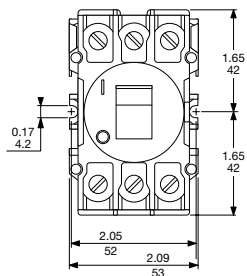

BACKPLATE TO DOOR DISTANCE WITH SHAFT EXTENSION (in/mm)

SELECTOR HANDLE TYPE M - SHAFT TRIMMING LENGTH (= DIMENSION L)

LBS M (16 up to 30 A)
LBS R (30 up to 40 A)

LBS R (60 up to 125 A)

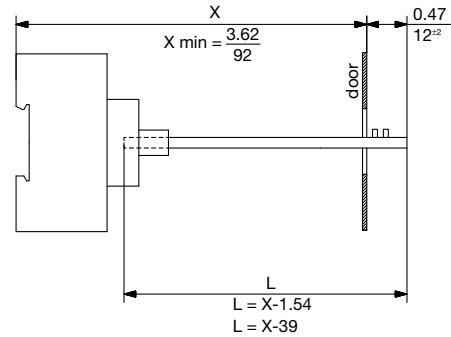
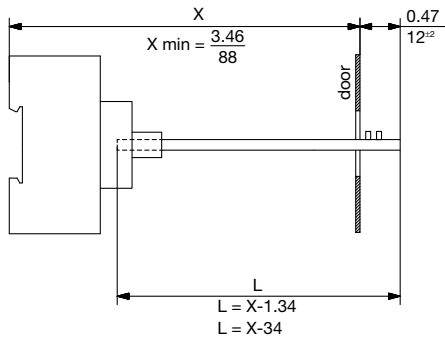

PISTOL HANDLE TYPE D - SHAFT TRIMMING LENGTH (= DIMENSION L)

LBS M (16 up to 30 A)
LBS R (30 up to 40 A)

LBS R (60 up to 125 A)

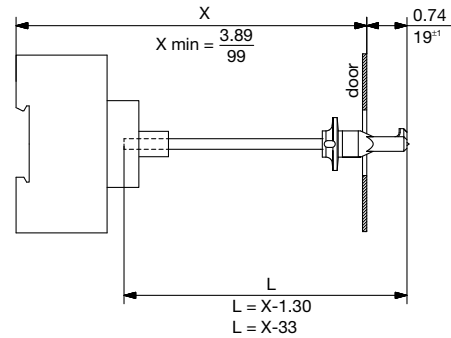
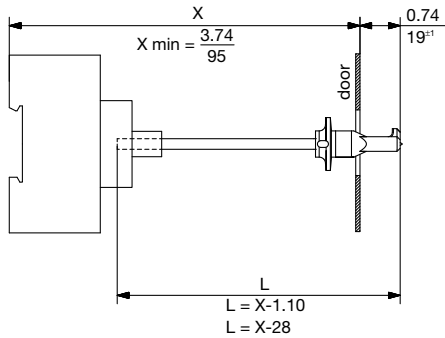

PISTOL HANDLE TYPE G - SHAFT TRIMMING LENGTH (= DIMENSION L)

LBS M (16 up to 30 A)
LBS R (30 up to 40 A)

LBS R (60 up to 125 A)

