

BOLT-IN SERIES E-RATED / MEDIUM VOLTAGE FUSES



HIGHLIGHTS:

- E-Rated
- UL Listed
- Complies with ANSI C37.46



DEFINITIONS:

E-rating

E-rated fuses operate as follows:

Over 100E - must melt in 600 seconds (10 mins.) on 220 to 264% of E (ampere) rating.

Example - A 750E fuse must melt in 600 seconds with an applied current of 1650 to 1980 amperes.

General Purpose Current-Limiting Fuse

A general purpose current-limiting power fuse is one that is capable of interrupting all currents from its rated interrupting rating down to the current that causes melting of the fusible element in one hour.

APPLICATIONS:

- Protection for 5.5kV transformers or distribution systems

5kV BOLT-IN FUSES

Amp-trap Bolt-in Series E-rated fuses are single, double or triple barrel (3" diam.) with end mounts designed for bolting directly to equipment bus or terminal pads. They are UL listed and are for use indoors (or outdoors in a weatherproof enclosure). The unique time-current characteristic of Ferraz Shawmut E-rated fuses allows them to be closely sized to transformer full load rated current, as recommended by IEEE guidelines, without being affected by normal magnetizing inrush current. Bolt-in fuses are typically sized at transformer rated current of 133%, thereby providing superior overall protection.

Features/Benefits

- **UL Listed** for compatibility with UL listed equipment
- **Bolt-in mounting** for direct connection to bus or terminals
- **Current Limiting** for superior equipment protection
- **Blown-fuse indicator** gives positive identification of open fuse
- **Non-venting** for silent operation
- **Metal Embossed Catalog Number** and manufacturing date for lasting identification

Ratings

- **A055B**
AC: 10E TO 900E
5500V max, 63kA I.R.
Sym.

Approvals

- UL Listed to JEEG, "Fuses Over 600 Volts"

UL File # E143362

BOLT-IN SERIES E-RATED / MEDIUM VOLTAGE FUSES

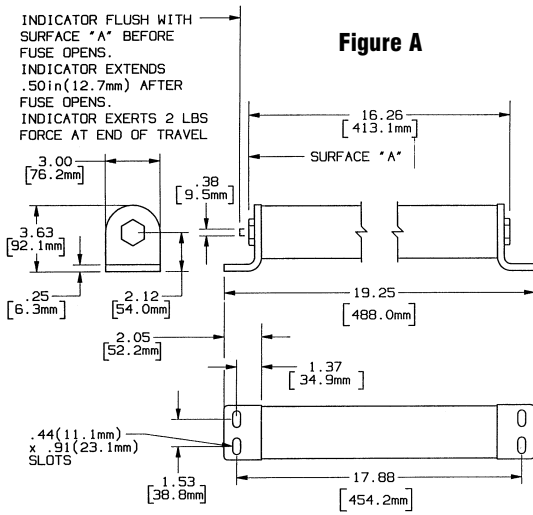

Figure A

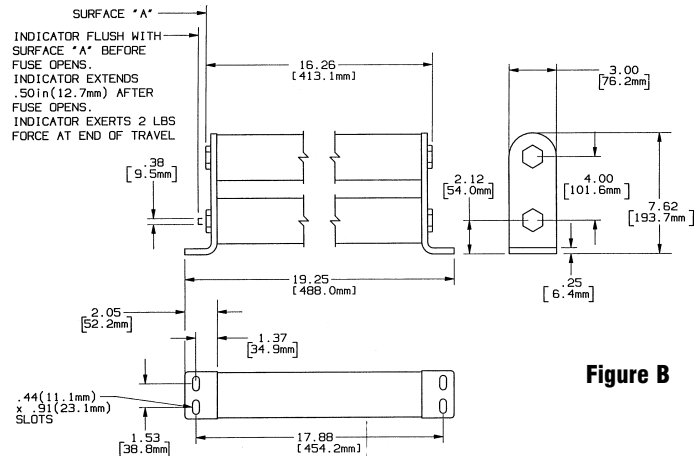

Figure B

Catalog Numbering System

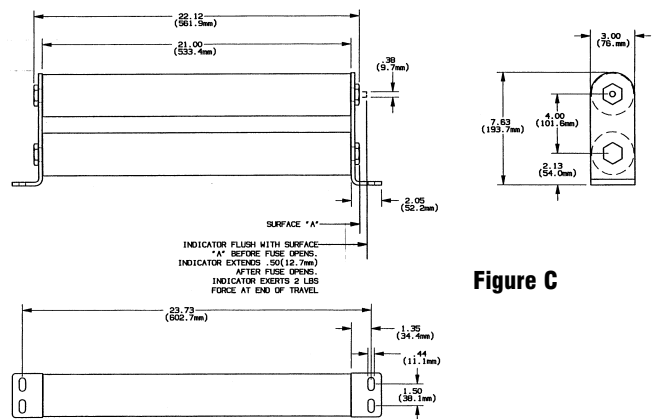
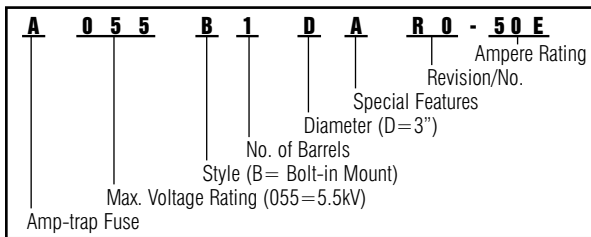

Figure C

CATALOG NUMBER	AMPERE RATING	NUMBER OF BARRELS	FIG.	INTERRUPTING RATING RMS SYM. AMPERES*
5.5kV MAX. BOLT-IN STYLE - 17.88 (454 mm) HOLE CENTER - 3" (76.2 mm) BARREL DIAMETER				
A055B1DARO-10E	10E	1	A	63,000
A055B1DARO-15E	15E	1	A	
A055B1DARO-20E	20E	1	A	
A055B1DARO-25E	25E	1	A	
A055B1DARO-30E	30E	1	A	
A055B1DARO-40E	40E	1	A	
A055B1DARO-50E	50E	1	A	
A055B1DARO-65E	65E	1	A	
A055B1DARO-80E	80E	1	A	
A055B1DARO-100E	100E	1	A	
A055B1DARO-125E	125E	1	A	
A055B1DARO-150E	150E	1	A	
A055B1DARO-175E	175E	1	A	
A055B1DARO-200E	200E	1	A	
5.5kV MAX. BOLT-IN STYLE - 17.88 (454 mm) HOLE CENTER - 3" (76.2 mm) BARREL DIAMETER				
A055B2DARO-250E	250E	2	B	63,000
A055B2DARO-300E	300E	2	B	
A055B2DARO-350E	350E	2	B	
A055B2DARO-400E	400E	2	B	
A055B2DARO-450E	450E	2	B	
5.5kV MAX. BOLT-IN STYLE - 23.73 (602.7 mm) HOLE CENTER - 3" (76.2 mm) BARREL DIAMETER				
A055B2DORO-450E	450E	2	C	63,000
A055B2DORO-500E	500E	2	C	
A055B2DORO-600E	600E	2	C	

* RMS ASYM. AMPS = RMS SYM. AMPERES x 1.6

BOLT-IN SERIES E-RATED / MEDIUM VOLTAGE FUSES

A055B1DARO - 10E to 200E - A055B2DARO - 250E to 450E

Total Clearing Time — Current Data

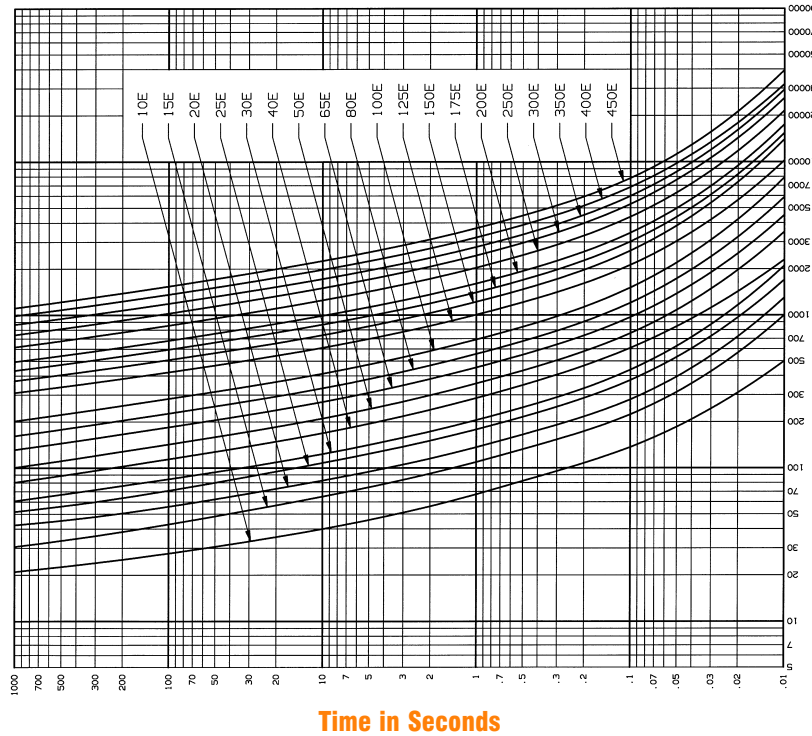

Current in Amps



A055B1DARO - 10E to 200E - A055B2DARO - 250E to 450E

Minimum Melting Time — Current Data

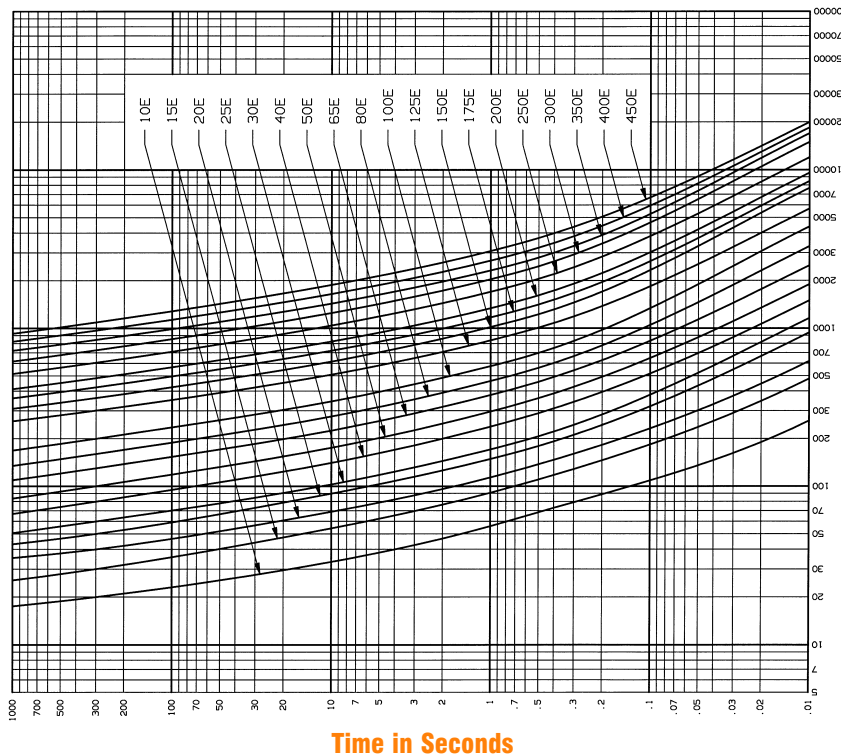

Current in Amps

BOLT-IN SERIES E-RATED / MEDIUM VOLTAGE FUSES

A055B2D0R0 - 450E to 600E

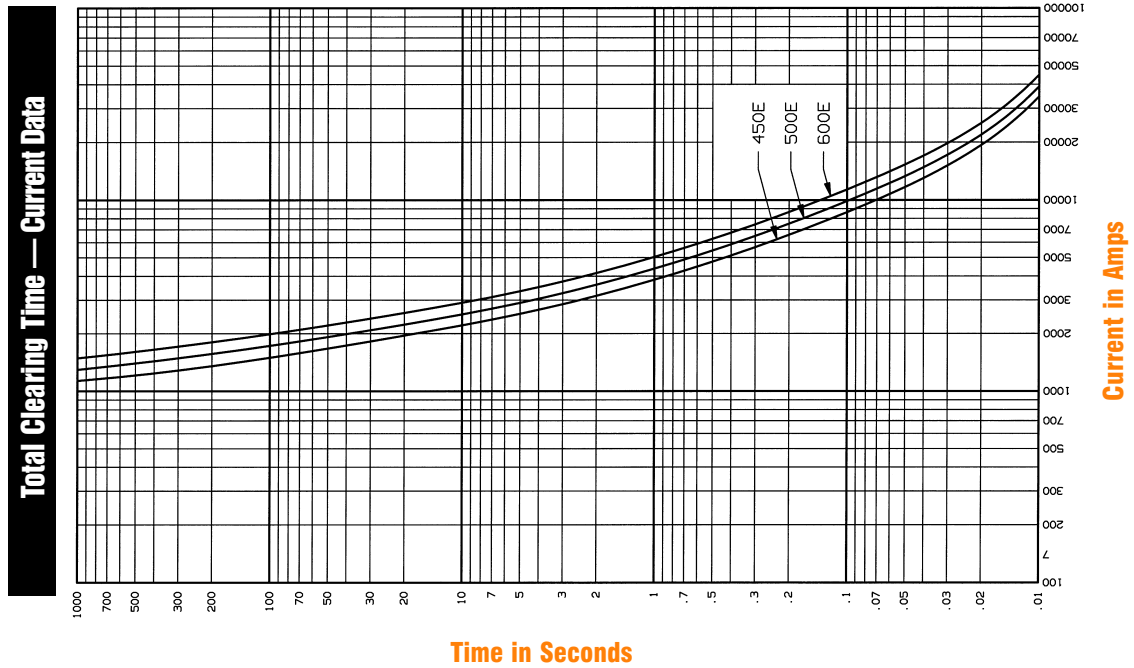

A055B2D0R0 - 450E to 600E

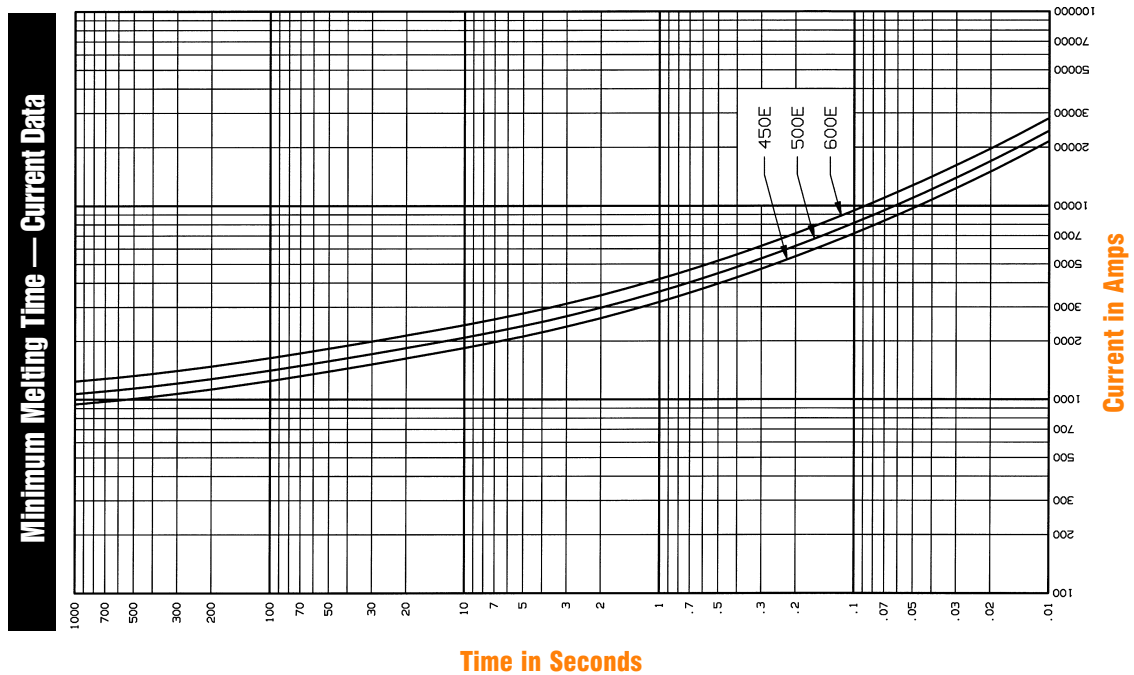

BOLT-IN SERIES E-RATED / MEDIUM VOLTAGE FUSES

A055B1DARO - 10E to 200E - A055B2DARO - 250E to 450E

Peak Let-Through Current Data, E-Rated Fuses

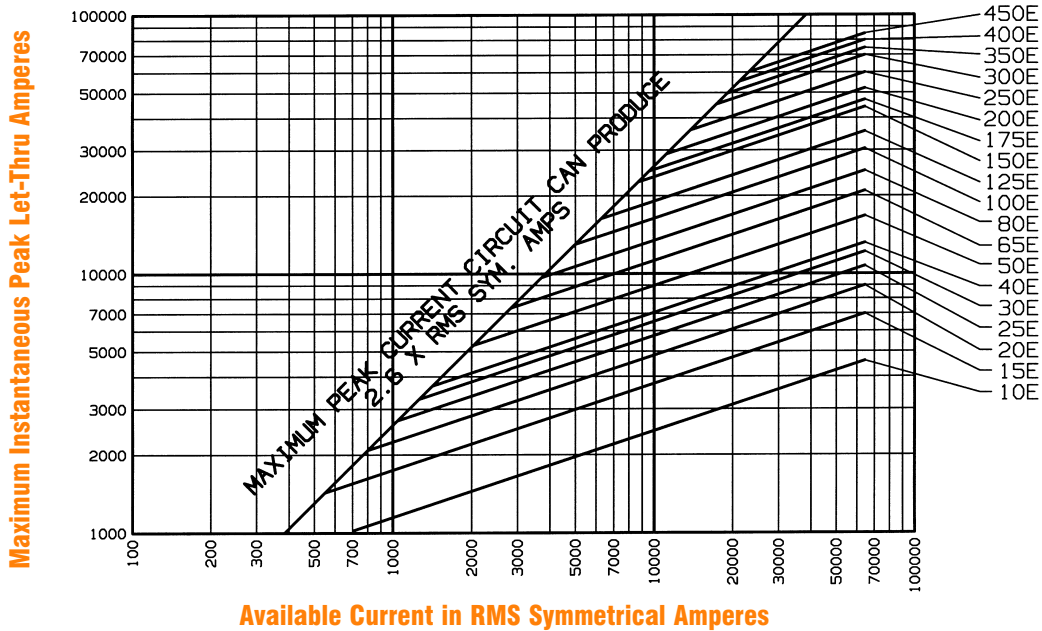

A055B2DORO - 450E to 600E

Peak Let-Through Current Data, E-Rated Fuses

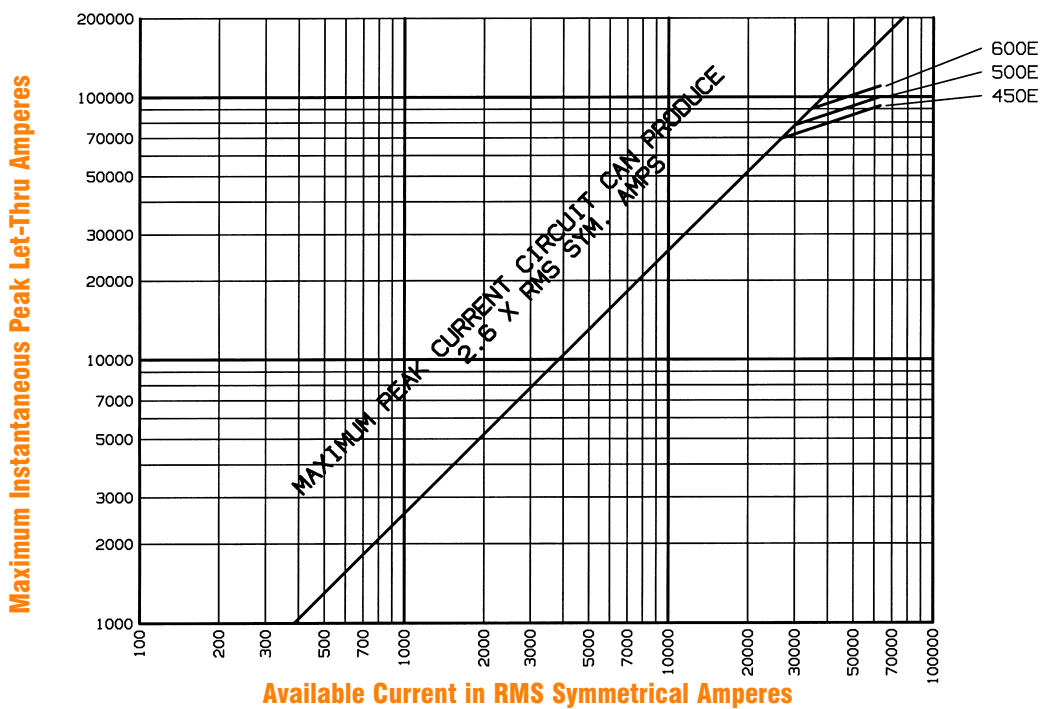

BOLT-IN

E-RATED / MEDIUM VOLTAGE FUSES / A055B

5.5kV Bolt-in

Catalog Numbering System

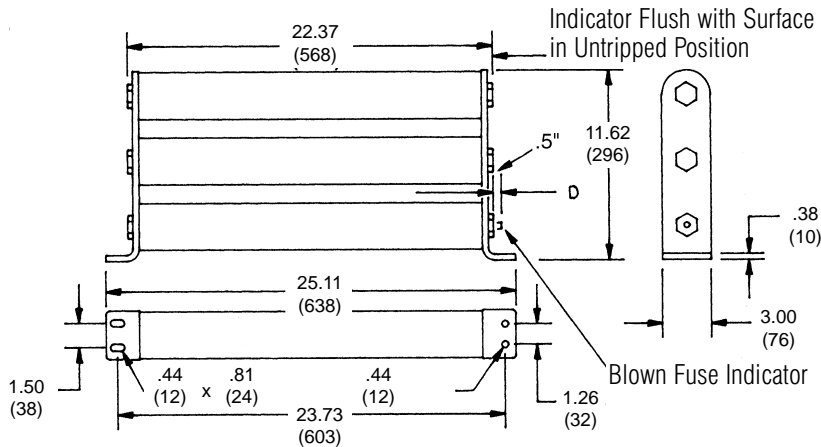
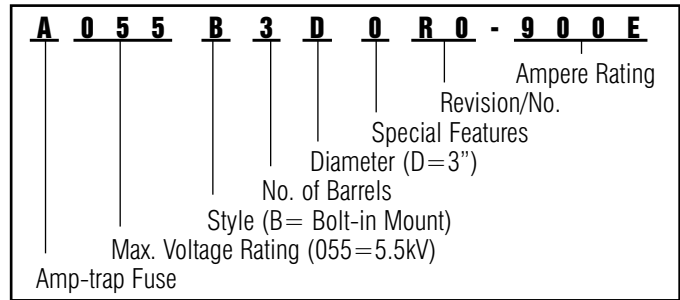

Catalog Numbers, Ratings, Dimensions, Bolt-in Series, 5.5kV

NEW CATALOG NUMBER	OLD CATALOG NUMBER	AMPERE RATING	NUMBER OF BARRELS	INTERRUPTING RATING RMS SYM.* AMPERES
5.5kV Max. — Bolt-in Style — 23.73 (603mm) Hole Centers — 3 (76.2mm) Barrel Diameter				
A055B3DOR0-750E A055B3DOR0-900E	A550X750E-4 A550X900E-4	750E 900E	3	63,000

* RMS ASYM. AMPERES = RMS SYM. AMPERES x 1.6

BOLT-IN

E-RATED / MEDIUM VOLTAGE FUSES / A055B

A055B3D0R0 — 750E to 900E

A055B3D0R0 — 750E to 900E

Minimum Melting Time — Current Data, 5.5kV Fuses

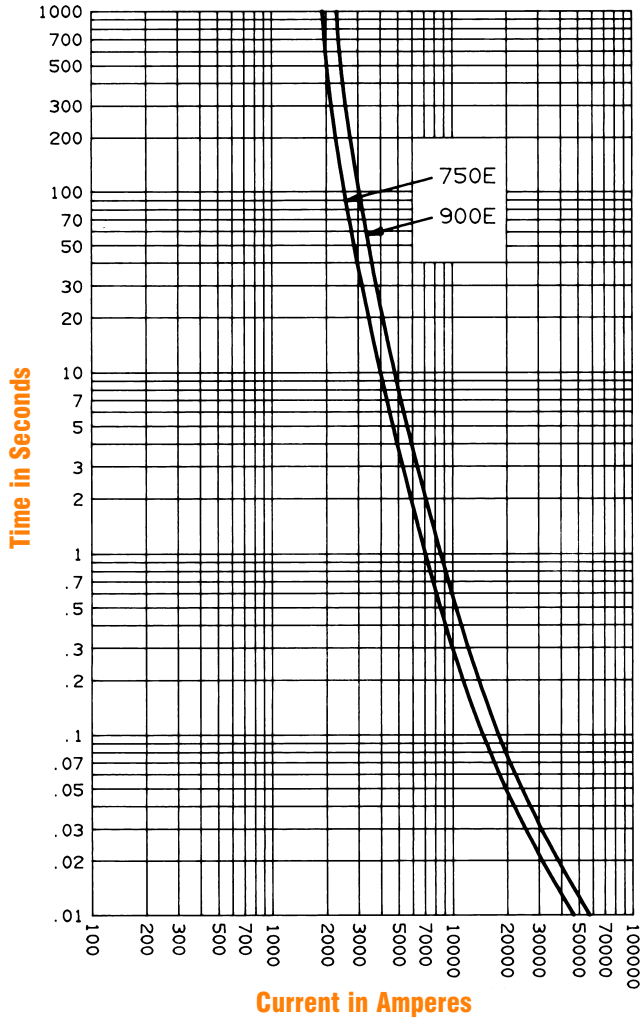

Total Clearing Time — Current Data, 5.5kV Fuses

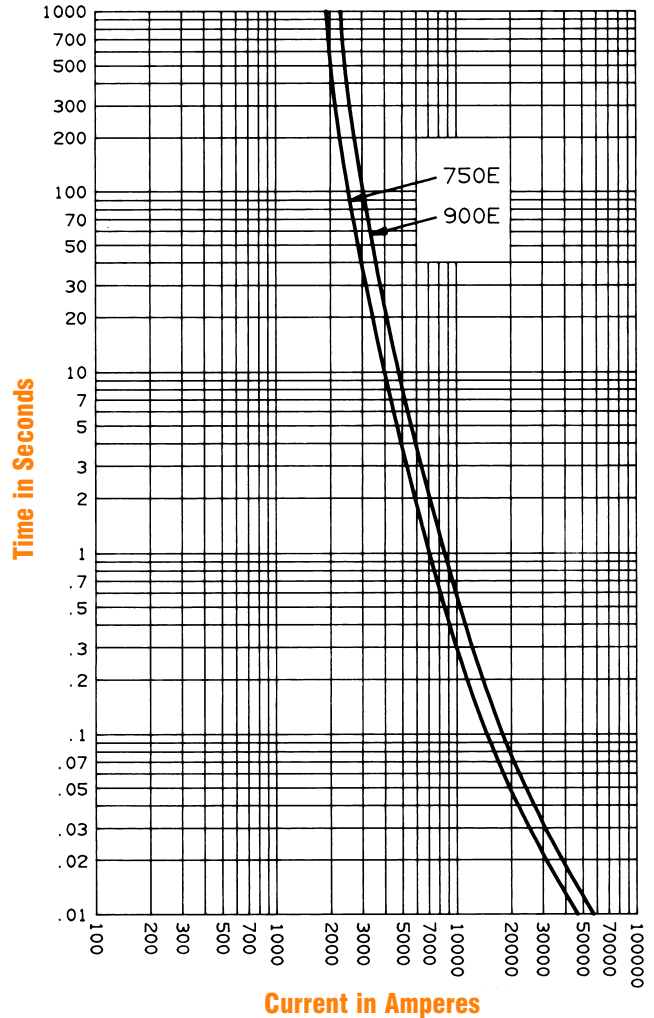

A055B3D0R0 — 750E to 900E

Peak Let-Thru Current Data — 5.5kV Bolt-in Fuses

