

# Capacitor Fuses

Current Limiting fuses with special terminals for direct coupling to capacitor bushings.

Type Amp-Trap® A6Y - 2SG  
Type Amp-Trap® A60C - 121

- 600 Volts A.C.
- Ampere Ratings 10 - 300 Amps
- Interrupting Ratings:  
Type A6Y - 2SG 100 kA RMS Sym.  
Type A60C - 121 200 kA RMS Sym.
- UL Component Recognized

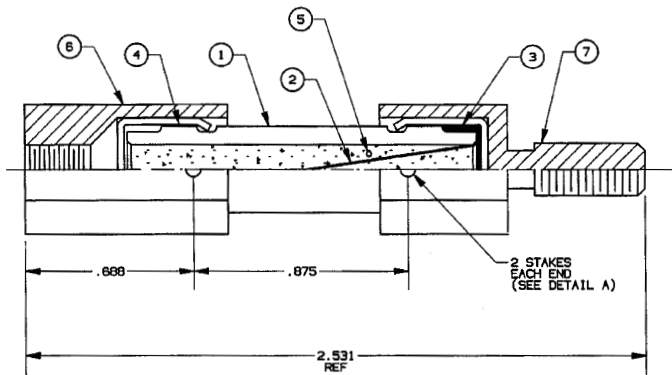
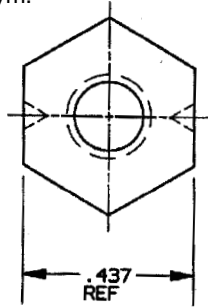

## A6Y-2SG Fuse Catalogue Numbers & Ampere Ratings

Catalogue Number	Ampere Rating	Catalogue Number	Ampere Rating
A6Y4-2SG	4	A6Y15-2SG	15
A6Y6-2SG	6	A6Y20-2SG	20
A6Y8-2SG	8	A6Y25-2SG	25
A6Y10-2SG	10	A6Y30-2SG	30

## A60C-121/TI Fuse Catalogue Numbers & Ampere Ratings

Catalogue Number	Ampere Rating	Catalogue Number	Ampere Rating	Catalogue Number	Ampere Rating
A60C10-121	10	A60C50-121	50	A60C150-121	150
A60C15-121	15	A60C60-121	60	A60C175-121	175
A60C20-121	20	A60C75-121	75	A60C200-121	200
A60C25-121	25	A60C80-121	80	A60C225-121	225
A60C30-121	30	A60C100-121	100	A60C250-121	250
A60C35-121	35	A60C125-121	125	A60C300-121	300

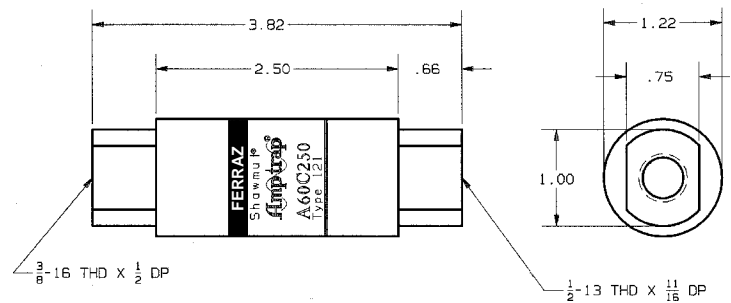

# Fork Lift Truck Fuses

## Stud-Mounted Fuse For Battery Operated Equipment Lift Trucks, Aircraft, Deep Sea Power, Etc.

- Five Characteristics
- CNN** - Fast Acting for Quick Response
  - CNL** - Slower Acting for Inertia Loads  
- UL Recognized
  - ACK** - Time Delay
  - ACL/ALS** - Fast Acting General Purpose

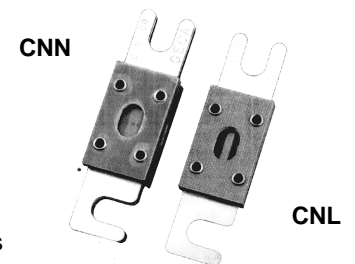

### Features

- All fuses are AC and DC rated
- Expanded Ampere Ratings
- Time Delay and General Purpose types
- Link is visible
- Embossed Catalog Numbers for permanent ID

### Ratings

- **ACK:** 1-400 Amperes  
125VAC, 10kA I.R.  
125VDC, 10kA I.R.
- **ACL:** 30-120 Amperes  
125VAC, 10kA I.R.  
125VDC, 10kA I.R.
- **ALS:** 100-500 Amperes  
125VAC, 10kA I.R.  
125VDC, 10kA I.R.

- **CNL:** 35-500 Amperes  
32V AC/DC, 2500A I.R.
- **CNN:** 10-500 Amperes  
125VAC, 48VDC, 2500A I.R.
- **CNN:** 600-800 Amperes  
125VAC, 48VDC, 2500A I.R.  
32VDC, 2500A I.R. (Ferraz Certified)

### Approvals

- UL Recognized Components (All Products)

AMP TRAP CAPACITOR FUSE

CONTROL NO: 138

ABOC(AMP RATING)-121 & -121T1  
10-300A 600VAC

REV. D  
8-31-99

GOULD SHAMMUT  
NEWBURYPORT, MA 01950

24142

UNCONTROLLED COPY

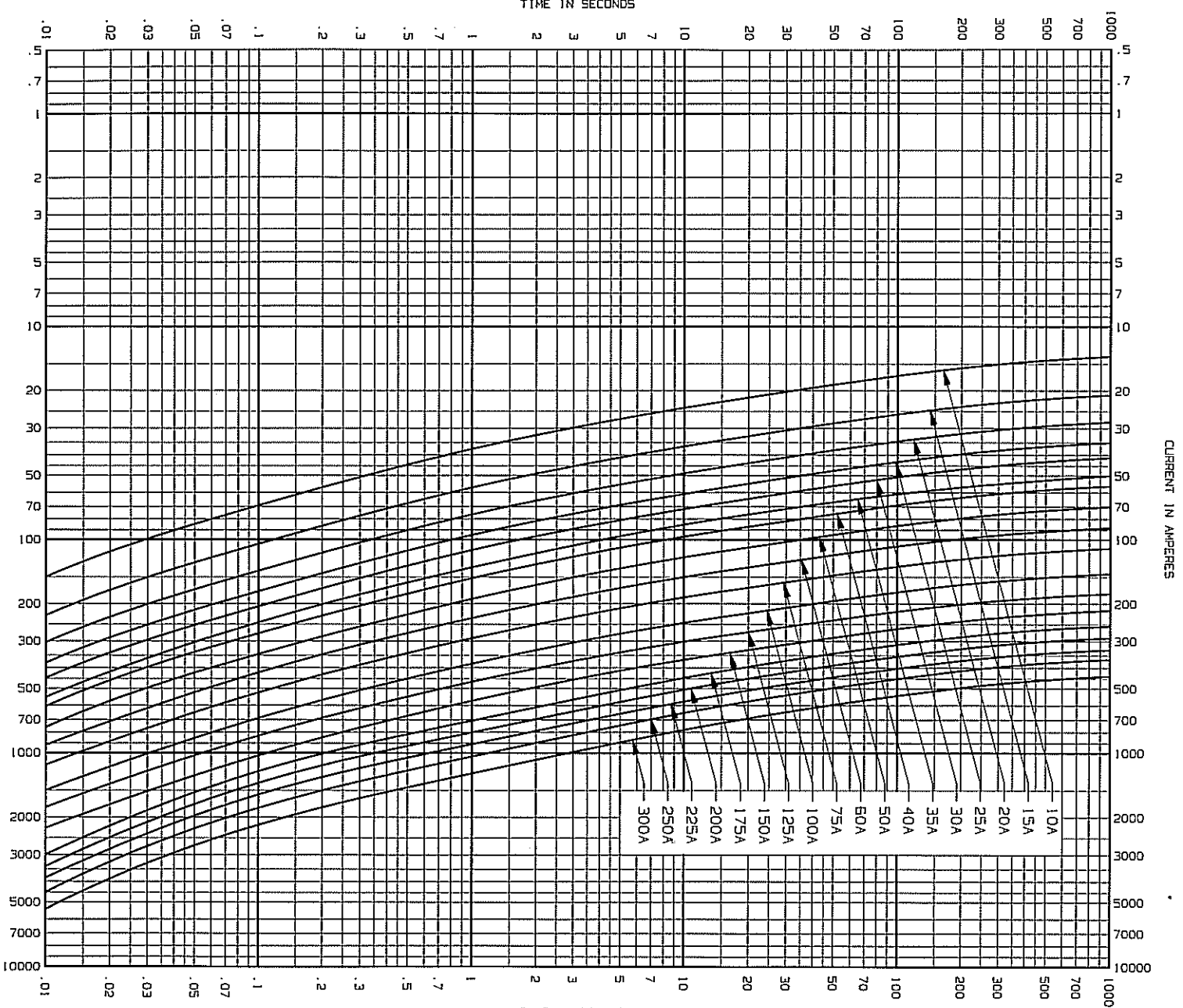

AMP TRAP CAPACITOR FUSE

CONTROL NO: 138

ABOC(AMP RATING)-121 & -121TI

REV. D

10-300A 500VAC

8-31-99

TOTAL CLEARING TIME-CURRENT CURVE

GOULD SHANNUT  
NEWBURYPORT, MA 01950

24143

UNCONTROLLED COPY

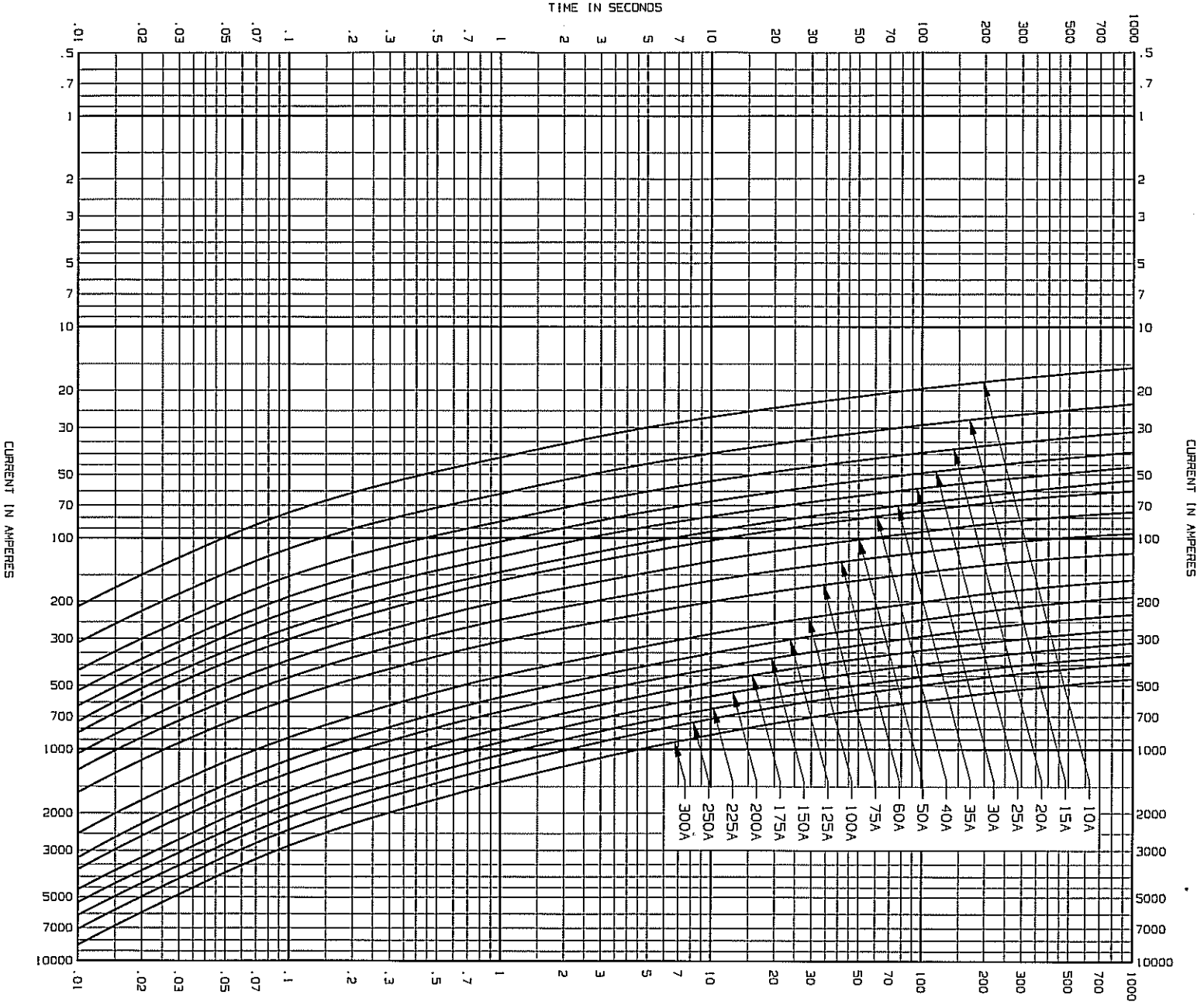

ASOC(AMP RATING)-121 & -121TI  
10-300A 600VAC

REV. D  
8-31-99

PEAK LET-THRU DATA

GOULD SHAWMUT  
NEWBURYPORT, MA 01950

24144

UNCONTROLLED COPY

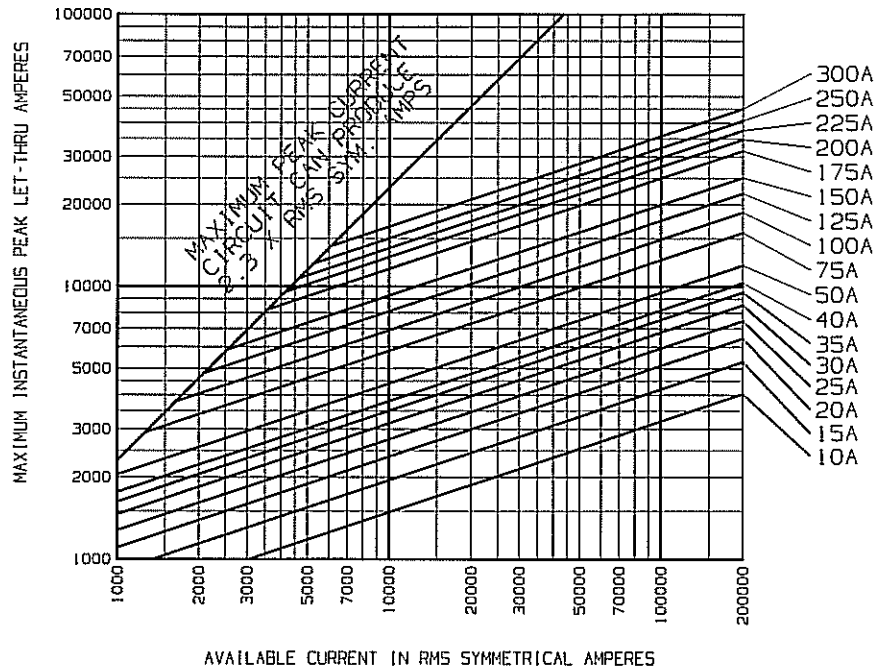

AMP TRAP CAPACITOR FUSE

ABOC(AMP RATING)-121 & 121TI  
10-300A 600VAC

REPRODUCED COPY

MAXIMUM LET-THRU I<sup>2</sup>t

GOULD SHAWMUT  
NEWBURYPORT, MA 01950

24155

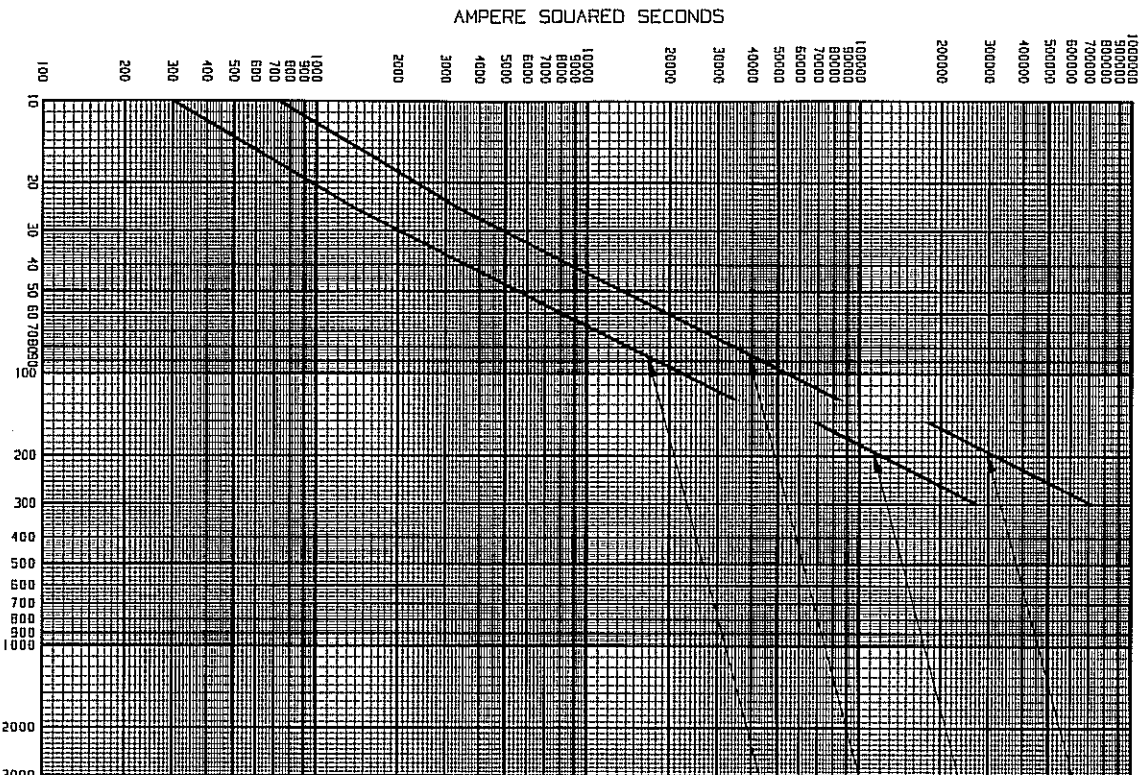

150-300 AMP  
TOTAL CLEARING I<sup>2</sup>t \*

150-300 AMP  
MELTING I<sup>2</sup>t

10-125 AMP  
TOTAL CLEARING I<sup>2</sup>t \*

10-125-AMP  
MELTING I<sup>2</sup>t

\* TOTAL CLEARING I<sup>2</sup>t  
6660V RMS AND  
200KA RMS SYM AVAILABLE

AMPERE RATING-AMPS

AMPERE SQUARED SECONDS

